



μChiller

Controller for Chiller / Heat Pump



USER MANUAL

→ LEGGI E CONSERVA
QUESTE ISTRUZIONI ←
→ READ AND SAVE
THESE INSTRUCTIONS ←

μChiller

+0300053EN - ENG

Up to date version available on

www.carel.com

GENERAL WARNINGS



CAREL bases the development of its products on decades of experience in HVAC/R, on continuous investments in technological innovations to products, procedures and strict quality processes with in-circuit and functional testing on 100% of its products, and on the most innovative production technology available on the market. CAREL and its subsidiaries/affiliates nonetheless cannot guarantee that all the aspects of the product and the software included with the product respond to the requirements of the final application, despite the product being developed according to start-of-the-art techniques. The customer (manufacturer, developer or installer of the final equipment) accepts all liability and risk relating to the configuration of the product in order to reach the expected results in relation to the specific final installation and/or equipment. CAREL may, based on specific agreements, act as a consultant for the successful commissioning of the final unit/application, however in no case does it accept liability for the correct operation of the final equipment/system. The CAREL product is a state-of-the-art product, whose operation is specified in the technical documentation supplied with the product or can be downloaded, even prior to purchase, from the website www.carel.com. Each CAREL product, in relation to its advanced level of technology, requires setup/configuration/programming/commissioning to be able to operate in the best possible way for the specific application. Failure to complete such operations, which are required/indicated in the user manual, may cause the final product to malfunction; CAREL accepts no liability in such cases. Only qualified personnel may install or carry out technical service on the product. The customer must only use the product in the manner described in the documentation relating to the product. In addition to observing any further warnings described in this manual, the following warnings must be heeded for all CAREL products:

- prevent the electronic circuits from getting wet. Rain, humidity and all types of liquids or condensate contain corrosive minerals that may damage the electronic circuits. In any case, the product should be used or stored in environments that comply with the temperature and humidity limits specified in the manual;
- do not install the device in particularly hot environments. Too high temperatures may reduce the life of electronic devices, damage them and deform or melt the plastic parts. In any case, the product should be used or stored in environments that comply with the temperature and humidity limits specified in the manual;
- do not attempt to open the device in any way other than described in the manual.
- do not drop, hit or shake the device, as the internal circuits and mechanisms may be irreparably damaged.
- do not use corrosive chemicals, solvents or aggressive detergents to clean the device.
- do not use the product for applications other than those specified in the technical manual.

All of the above suggestions likewise apply to the controllers, serial cards, programming keys or any other accessory in the CAREL product portfolio.

CAREL adopts a policy of continual development. Consequently, CAREL reserves the right to make changes and improvements to any product described in this document without prior warning. The technical specifications shown in the manual may be changed without prior warning. The liability of CAREL in relation to its products is specified in the CAREL general contract conditions, available on the website www.carel.com and/or by specific agreements with customers; specifically, to the extent where allowed by applicable legislation, in no case will CAREL, its employees or subsidiaries/affiliates be liable for any lost earnings or sales, losses of data and information, costs of replacement goods or services, damage to things or people, downtime or any direct, indirect, incidental, actual, punitive, exemplary, special or consequential damage of any kind whatsoever, whether contractual, extra-contractual or due to negligence, or any other liabilities deriving from the installation, use or impossibility to use the product, even if CAREL or its subsidiaries/affiliates are warned of the possibility of such damage.

DISPOSAL



INFORMATION FOR USERS ON THE CORRECT HANDLING OF WASTE ELECTRICAL AND ELECTRONIC EQUIPMENT (WEEE)

The product is made up of metal parts and plastic parts. In reference to European Union directive 2002/96/EC issued on 27 January 2003 and related national legislation, please note that:

- WEEE cannot be disposed of as municipal waste and such waste must be collected and disposed of separately;
- the public or private waste collection systems defined by local legislation must be used. In addition, the equipment can be returned to the distributor at the end of its working life when buying new equipment;
- the equipment may contain hazardous substances: the improper use or incorrect disposal of such may have negative effects on human health and on the environment;
- the symbol (crossed-out wheeled bin) shown on the product or on the packaging and on the instruction sheet indicates that the equipment has been introduced onto the market after 13 August 2005 and that it must be disposed of separately;
- in the event of illegal disposal of electrical and electronic waste, the penalties are specified by local waste disposal legislation.

Warranty on materials: 2 years (from production date, excluding consumables).

Approval: the quality and safety of CAREL S.p.A. products are guaranteed by the ISO 9001 certified design and production system.

IMPORTANT



Separate as much as possible the probe and digital input cables from cables to inductive loads and power cables, so as to avoid possible electromagnetic disturbance. Never run power cables (including the electrical panel cables) and signal cables in the same conduits.

Key to the symbols:

- ⚠ Important:** to bring critical issues to the attention of those using the product.
- 🔍 Note:** to focus attention on important topics; in particular the practical application of the various product functions.

⚠ Important: This product is to be integrated and/or incorporated into the final apparatus or equipment. Verification of conformity to the laws and technical standards in force in the country where the final apparatus or equipment will be operated is the manufacturer's responsibility. Before delivering the product, Carel has already completed the checks and tests required by the relevant European directives and harmonised standards, using a typical test setup, which however cannot be considered as representing all possible conditions of the final installation.

Index

1. INTRODUCTION	7		
1.1 Main functions	7		
1.2 Models	8		
1.3 Accessories	8		
2. INSTALLATION	12		
2.1 Warnings	12		
2.2 Panel version	12		
2.3 DIN rail version	13		
2.4 Electrical installation	13		
2.5 Probe connection	15		
2.6 Positioning inside the panel	16		
2.7 Electrical installation	16		
2.8 Connecting serial ports with two circuits	16		
2.9 Connection to Power+ (for BLDC)	17		
2.10 Positioning of probes/components	18		
2.11 Functional diagrams	19		
3. COMMISSIONING	35		
3.1 APPLICA app	35		
3.2 Applica Desktop	38		
4. USER INTERFACE	41		
4.1 Introduction	41		
4.2 User terminal	41		
4.3 Standard display	42		
5. FUNCTIONS	46		
5.1 Temperature control	46		
5.2 User pumps	49		
5.3 Frost protection control	50		
5.4 Compressor rotation	53		
5.5 Compressor management	54		
5.6 BLDC compressor protectors	56		
5.7 BLDC comp. alarm prevention	58		
5.8 Compressor alarms	61		
5.9 Power+ Speed drive	61		
5.10 Expansion valve driver	61		
5.11 Control of the expansion valve	62		
5.12 Source pump	62		
5.13 Source fans	62		
5.14 Free cooling	66		
5.15 Types of free cooling	66		
5.16 Free cooling functions	69		
5.17 Defrost	70		
5.18 4-way valve management	76		
5.19 Manual device management	76		
6. PARAMETER TABLE	77		
6.1 System	77		
6.2 Compressor	79		
6.3 BLDC and Inverter	81		
6.4 Valve	81		
6.5 Source	82		
6.6 I/O settings	84		
6.7 BMS port	86		
6.8 Password	86		
6.9 Dashboard values	86		
6.10 Settings	88		
6. SUPERVISOR TABLE	89		
6.1 Coil Status	89		
6.2 Input Status	90		
6.3 Holding Register	92		
6.4 Input Register	96		
7. ALARMS AND SIGNALS	98		
7.1 Types of alarms	98		
7.2 Alarm list	99		
8. TECHNICAL SPECIFICATIONS	102		
8.1 Connector/cable table	103		
9. RELEASE NOTES	105		

1. Introduction

µChiller is the Carel solution for complete management of air/water and water/water chillers and heat pumps. The maximum configuration manages 2 compressors per circuit (On/Off or BLDC), up to a maximum of 2 circuits (using an expansion card for circuit 2). The distinctive element of µChiller is complete control of high-efficiency units through integrated management of electronic expansion valves and brushless BLDC compressors, thus ensuring greater compressor protection and reliability and a high-efficiency unit. The user terminal allows wireless connectivity with mobile devices and is built-in on the panel mounted models, or sold separately on DIN rail mounted models. CAREL's "APPLICA" app, available on Google Play for the Android operating system, makes it easier to configure parameters and commission the unit in the field.

1.1 Main functions

Ref.	Description
Main features	Up to two circuits and 2 + 2 compressors
	Compressors in tandem configuration with possible BLDC compressor
	Air/water chiller or heat pump (A/W)
	Water/water chiller or heat pump (W/W)
	1 evaporator per unit
	Air-cooled condenser with separate/shared air circuit for A/W units
Hardware	Water-cooled condenser with single circuit for W/W units
	Panel mounted model: management of ON-OFF compressors
	DIN rail mounted model: management of ON-OFF compressors
	DIN rail mounted model, enhanced: management of ON-OFF compressors
User interface	DIN rail mounted model, high efficiency: management of BLDC compressors
	7-segment, 2-row LED display, optional pGDx graphic display, communication via APPLICA app (compatible with NFC and BTLE) for mobile devices
Temperature control	PID at start-up
	PID in operation
	Set point compensation on outdoor temperature
Compressor rotation	FIFO or timed
Compressor management	Specific BLDC compressors (see list on KSA - µChiller section)
	Generic scroll compressors
Oil management with BLDC	Oil recovery function (extended operation at part load)
	Oil equalisation (tandem with BLDC compressor)
Circuit destabilisation	Forced compressor rotation (extended operation at part load)
ExV driver	Built-in valve driver on enhanced and high efficiency models
	External driver management via FieldBus port (all versions)
Programming with time bands	Unit ON-OFF or 2nd set point (1 time band per day)
	"Noise reduction" function for condenser fans (1 time band per day)
User pumps	1/2 pumps (2 pumps only with 2 circuits)
	Rotation by time or with pump overload alarm
Water-cooled condenser	1 common pump for both circuits
Air-cooled condenser	Independent fans on each circuit or common to both circuits
	Fan modulation based on condensing temperature (On/Off fan control via CAREL CONVONOFF0 module)
	Optimised start-up to quickly bring the compressor(s) to steady operation
	Fan anti-block protection (harsh climate)
Defrost	Simultaneous
	Separate
	Independent
	Defrost interval managed based on outside temperature ("sliding defrost")
Prevent	Prevention of scroll compressor operating limits in relation to condensing and evaporation temperature
	Evaporator frost prevention
	Total management of the BLDC compressor envelope limits
Alarms	Management of automatic and manual reset according to alarm severity (see the chapter on

Ref.	Description
	Alarms)
	Alarm log (up to 20 events): alarm and reset date and time recorded
Connectivity/supervision	RS485 serial port
	Modbus RTU
	Baud rate up to 115200 bit/s
	Frame configurable by Parity (None, Even, Odd) and StopBits (1 or 2); Databits fixed at 8 bits.

Tab.1.a

1.2 Models

P/N	Mounting	Connectivity	Compressor management:	Notes	Electronic expansion valve management
UCHBP00000090	panel	NFC	On/Off		bipolar: with EVD Evolution driver
UCHBP00000100	panel	NFC, Bluetooth (BLE)	On/Off		bipolar: with EVD Evolution driver
UCHBD00001130	DIN rail	-	On/Off		bipolar: with EVD Evolution driver
UCHBDE0001140	DIN rail	-	On/Off	enhanced version	unipolar: built-in; bipolar: with external EVD Evolution driver
UCHBDH0001150	DIN rail	-	On-Off and BLDC	high efficiency version	unipolar: built-in; bipolar: with external EVD Evolution driver
UCHBE00001130: circuit expansion	2nd DIN rail	-	On/Off		bipolar: with external EVD Evolution driver
UCHBE00001140: circuit expansion	2nd DIN rail	-	On/Off	enhanced version	unipolar: built-in; bipolar: with external EVD Evolution driver

Tab.1.b

1.3 Accessories

1.3.1 User terminal

For DIN rail mounted models (built-in on the panel model). The user terminal includes the display and keypad, comprising four buttons that, when pressed alone or combined with other buttons, access the operations available for the "User" and "Service" profiles (see the paragraph on "Commissioning"). Connectivity - NFC or NFC + Bluetooth (BLE) based on the model - allows interaction with mobile devices and simplifies unit commissioning (after having installed the CAREL "Applica" APP for the Android operating system, see chapters "Commissioning" and "User interface"). For assembly, see the technical leaflet +05001461E.



Fig.1.a

P/N	Description
AX5000PD20A20	User terminal (NFC)
AX5000PD20A30	User terminal (NFC, Bluetooth BLE)

P/N	Description
ACS00CB000020	Connection cable L=1.5 m
ACS00CB000010	Connection cable L=3 m

Tab.1.c

1.3.2 EVD Evolution/EVD Evolution twin valve driver

The Enhanced and High Efficiency models have the driver built-into the controller, able to drive unipolar valves (up to Carel model E3V, with a cooling capacity less than 90-100kW); all versions can be connected to the external EVD Evolution driver to drive bipolar valves (with a higher cooling capacity).



Fig.1.b

1.3.3 Temperature sensors

NTC sensors for measuring the temperatures in the user circuit, the outdoor air or source, and the refrigeration circuit. NTC**HT sensors are recommended for discharge temperature measurement (with BLDC compressors in heat pump mode).



Fig.1.c

P/N	Type	Range
NTC060HF01	10 kΩ ±1% @25°C, IP67	-50 to 90°C strap-on
NTC060HP00	10 kΩ ±1% @25°C, IP67	-50 to 50 °C (105°C in air)
NTC060HT00	50 kΩ ±1% @25°C, IP67	-30 to 100°C RH95% in air (150°C in a dry environment)

Tab.1.d

➔ **Note:** see manual +040010025 (ITA- ENG) /+040010026 (FRE-GER) for guidelines on installing the sensors on the unit.

1.3.4 Pressure sensors

These measure:

1. evaporation pressure in the circuit, used to control superheat, manage the evaporator frost protection function and the operating limits;
2. condensing pressure in the circuit, to control the condensing stage and manage the operating limits.

See the technical leaflets +050000488.



Fig.1.d

P/N	Type	Application	Range
SPKT0*13P*	0-5V	LP R407C, R290	-1 to 9.3 bars
SPKT0*43P*	0-5V	LP R410A, R32	0 to 17.3 bars
SPKT0*33P*	0-5V	HP R407C, R290	0 to 34.5 bars
SPKT0*B6P*	0-5V	HP R410A, R32	0 to 45 bars
SPKT0011C*	4-20mA	LP R407C, R290	0 to 10 bars
SPKT0041C*	4-20mA	LP R410A, R32	0 to 18.2 bars
SPKT0031C*	4-20mA	HP R407C, R290	0 to 30 bars
SPKT00B1C*	4-20mA	HP R410A, R32	0 to 44.8 bars
SPKC00*310	IP67 connection cable		L=2 to 12 m
SPKC00*311	IP67 connection cable - 50 pcs		L=0.65 to 1.3 m

Tab.1.e

1.3.5 Unipolar valve (P/N E2V**FSAC*)

Used with a compatible stator from the E2VSTA03**series. Unipolar electronic expansion valve, managed directly by the controller, which guarantees precise refrigerant flow even at low flow-rates. See the technical leaflets +050001680.



Fig.1.e

1.3.6 Ultracap module (EVD0000UC0)

The Ultracap module EVD0000UC0 is an optional external backup module for the EVD Evolution driver that ensures the valves are closed in the event of a power failure. The module guarantees temporary power supply to one EVD Evolution driver (single or twin) only in the event of a power failure, for enough time to immediately close the connected electronic valves (one or two). It therefore also avoids the need to install a solenoid valve in the refrigeration circuit, or a backup coil kit.



Fig.1.f

1.3.7 USB/RS485 converter (CVSTDUMOR0)

Electronic device used to interface an RS485 network to a personal computer via the USB port. See the technical leaflets +050000590.

**Fig.1.g**

2. Installation

2.1 Warnings

- ⚠ Important:** avoid installing the controller in environments with the following characteristics:
- temperature and humidity that do not comply with the ambient operating conditions (see "Technical specifications");
 - strong vibrations or knocks;
 - exposure to water sprays or condensate;
 - exposure to aggressive and polluting atmospheres (e.g.: sulphur and ammonia gases, saline mist, smoke) which may cause corrosion and/or oxidation;
 - strong magnetic and/or radio frequency interference (thus avoid installation near transmitting antennae);
 - exposure to direct sunlight and the elements in general;
 - wide and rapid fluctuations in ambient temperature;
 - exposure to dust (formation of corrosive patina with possible oxidation and reduction of insulation).

2.2 Panel version

2.2.1 Dimensions - mm (in)

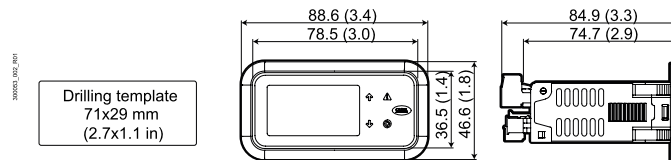

Fig.2.a

2.2.2 Mounting

- ⚠ Important:** before carrying out any maintenance, disconnect the controller from the power supply by moving the main system switch to "off".

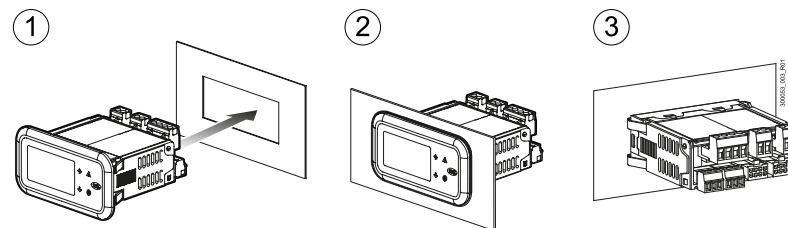

Fig.2.b

1. Place the controller in the opening, pressing lightly on the side anchoring tabs.
2. Then press on the front until fully inserted (the side tabs will bend, and the catches will attach the controller to the panel).

- ⚠ Important:** IP65 front protection is guaranteed only if the following conditions are met:

- maximum deviation of the rectangular opening from flat surface: ≤ 0.5 mm;
 - thickness of the electrical panel sheet metal: 0.8-2 mm;
 - maximum roughness of the surface where the gasket is applied: ≤ 120 μ m.
- 🔍 Note:** the thickness of the sheet metal (or material) used to make the electrical panel must be adequate to ensure safe and stable mounting of the product..

2.2.3 Removal

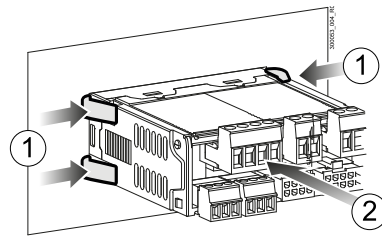

Fig.2.c

Open the electrical panel from the rear and press the anchoring tabs and then the controller to remove it.

1. Gently press the side anchoring tabs on the controller;
2. Exert slight pressure on the controller until it is removed.

⚠ Important: the operation does not require the use of a screwdriver or other tools.

2.3 DIN rail version

2.3.1 Dimensions - mm (in)

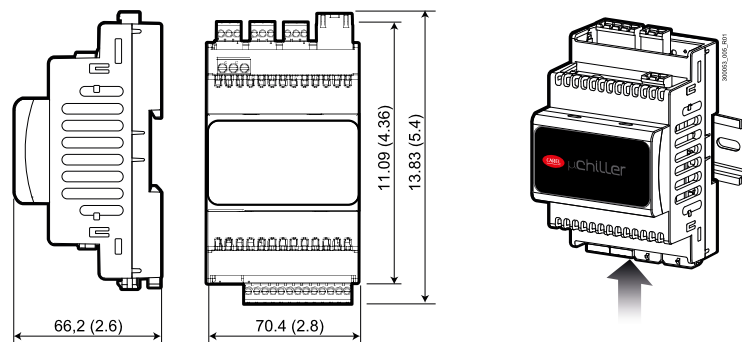

Fig.2.d

Apply slight pressure to the controller resting on the DIN rail until the rear tab clicks into place.

2.3.2 Removal

Use a screwdriver as a lever in the hole to lift and release the tab. The tab is held in the locked position by return springs.

⚠ Important: before carrying out any maintenance, disconnect the controller from the power supply by moving the main system switch to "off".

2.4 Electrical installation

2.4.1 Description of the terminals

Panel model

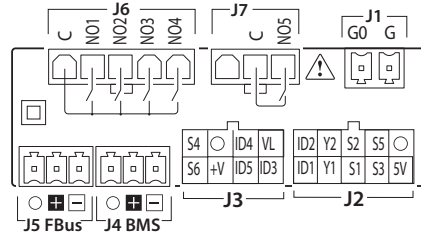
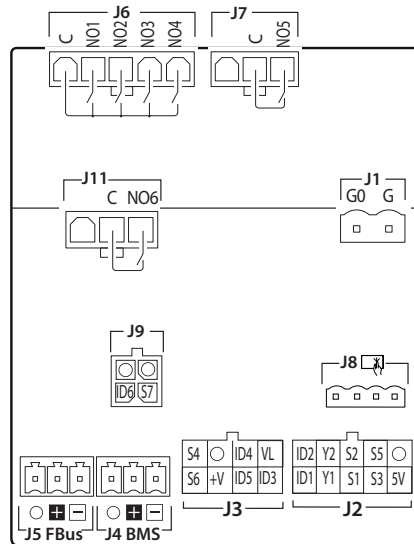
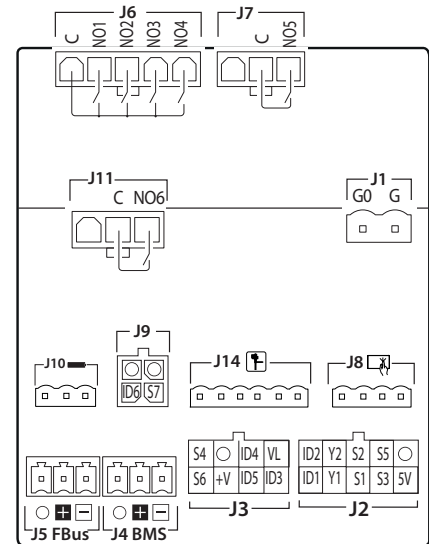

Fig.2.e

DIN rail model



Basic



Enhanced / High Efficiency

Fig.2.f

Ref.	Description	
J1	G	Power supply
	G0	Power supply: reference
J2	5V	Ratiometric probe power supply
	S3	Analogue input 3
	S1	Analogue input 1
	Y1	Analogue output 1
	ID1	Digital input 1
	O	GND: reference for probes, digital inputs and analogue outputs
	S5	Analogue input 5
	S2	Analogue input 2
	Y2	Analogue output 2
	ID2	Digital input 2

Ref.	Description	
J3	ID3	Digital input 3
	ID5	Digital input 5
	+V	Power supply to 4-20 mA active probes
	S6	Analogue input 6
	VL	Not used
	ID4	Digital input 4
	O	GND: reference for analogue and digital inputs
	S4	Analogue input 4
J4	-	BMS serial port (RS485): Rx/Tx-
	+	BMS serial port (RS485): Rx/Tx+
	O	BMS serial port (RS485): GND
J5	-	Fieldbus serial port (RS485): Rx/Tx -
	+	Fieldbus serial port (RS485): Rx/Tx +
	O	Fieldbus serial port (RS485): GND
J6	C	Common for relays 1, 2, 3, 4
	NO1	Digital output (relay) 1
	NO2	Digital output (relay) 2
	NO3	Digital output (relay) 3
	NO4	Digital output (relay) 4
J7	C	Common for relay 5
	NO5	Digital output (relay) 5
J8	-	Remote terminal connector
J9	S7	Analogue input 7
	ID6	Digital input 6
	O	Input reference
	O	Input reference
J10(*)	G	Ultracap module power supply (future use)
	G0	
	Vbat	Emergency power supply from Ultracap module (future use)
J11	-	(not used)
	C	Common for relay 6
	NO6	Digital output (relay) 6
J14(*)		Carel ExV unipolar valve connector

Tab.2.a

(*) for DIN Enhanced / High Efficiency models only

2.5 Probe connection

NTC probes

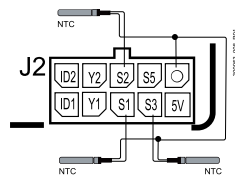

Fig.2.g

4-20 mA probes

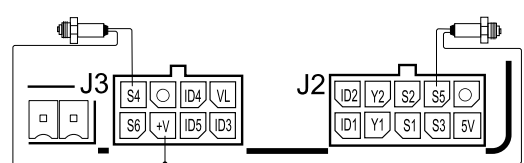

Fig.2.h

0-10 Vdc probes

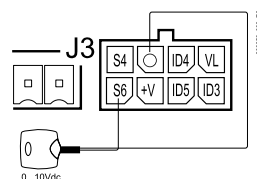

Fig.2.i

0-5 V ratiometric pressure probes

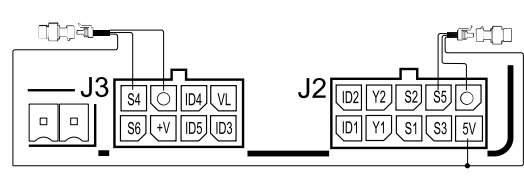

Fig.2.j

➡ **Note:** O = GND

2.6 Positioning inside the panel

The position of the controller in the electrical cabinet must be chosen so as to guarantee correct physical separation from the power components (solenoids, contactors, actuators, inverters, ...) and the connected cables. Proximity to such devices/cables may create random malfunctions that are not immediately evident. The structure of the panel must allow the correct flow of cooling air.

2.7 Electrical installation

⚠ Important:

When laying the wiring, "physically" separate the power part from the control part. The proximity of these two sets of wires will, in most cases, cause problems of induced disturbance or, over time, malfunctions or damage to the components. The ideal solution is to house these two circuits in two separate cabinets. Sometimes this is not possible, and therefore the power part and the control part must be installed in two separate areas inside the same panel.

For the control signals, it is recommended to use shielded cables with twisted wires. If the control cables have to cross over the power cables, the intersections must be as near as possible to 90 degrees, always avoiding running the control cables parallel to the power cables.

Pay attention to the following warnings:

- use cable ends suitable for the corresponding terminals. Loosen each screw and insert the cable ends, then tighten the screws. When the operation is completed, slightly tug the cables to check they are sufficiently tight;
- separate as much as possible the probe signal, digital input and serial line cables from the cables carrying inductive loads and power cables to avoid possible electromagnetic disturbance. Never run power cables (including the electrical cables) and probe signal cables in the same conduits. Do not install the probe cables in the immediate vicinity of power devices (contactors, circuit breakers or similar);
- reduce the path of the probe cables as much as possible, and avoid spiral paths that enclose power devices;
- avoid touching or nearly touching the electronic components fitted on the boards to avoid electrostatic discharges (extremely damaging) from the operator to the components;
- do not secure the cables to the terminals by pressing the screwdriver with excessive force, to avoid damaging the controller: maximum tightening torque 0.22-0.25 N•m;
- for applications subject to considerable vibrations (1.5 mm pk-pk 10/55 Hz), secure the cables connected to the controller around 3 cm from the connectors using clamps;
- all the extra low voltage connections (analogue and digital inputs, analogue outputs, serial bus connections, power supplies) must have reinforced or double insulation from the mains network.

2.8 Connecting serial ports with two circuits

For serial connections (FBus and BMS ports), the cables used must be suitable for the RS485 standard (shielded twisted pair, see the specifications in the following table). The earth connection of the shield must be made using the shortest connection possible on the metal plate at the bottom of the electrical panel.

Master device	Serial port	Lmax (m)	Wire/wire capacitance (pF/m)	Resistance on first and last device	Max no. of slave devices on bus	Data rate (bit/s)
μChiller	FBus	10	<90	120 Ω	16	19200
PC (supervision)	BMS	500	<90	120 Ω	16	115200

➡ **Note:** 120 Ω 1/4W terminating resistors on the first and last devices in the network must be used when the length exceeds 100 m.

For two-circuit units, the power supply connections must be in phase between the two controllers (G0 on the master controller and G0 on the slave controller connected to the same power supply wire); the serial connection between the two controllers (J5 FBus on the master and J4 BMS on the slave) must be made as shown in the figure (+ with + and - with -).

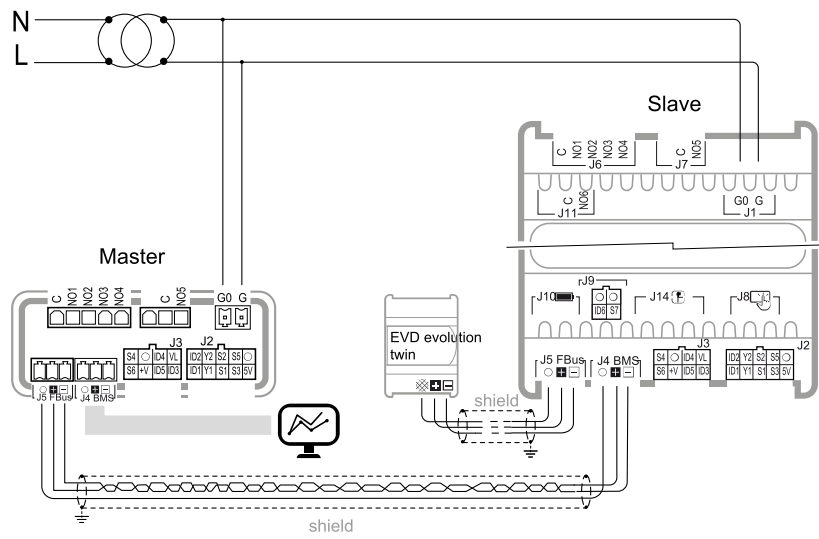

Fig.2.k

2.9 Connection to Power+ (for BLDC)

For the serial connection between the controller and the Power+ driver, see the specific manual. Also see the following diagram.

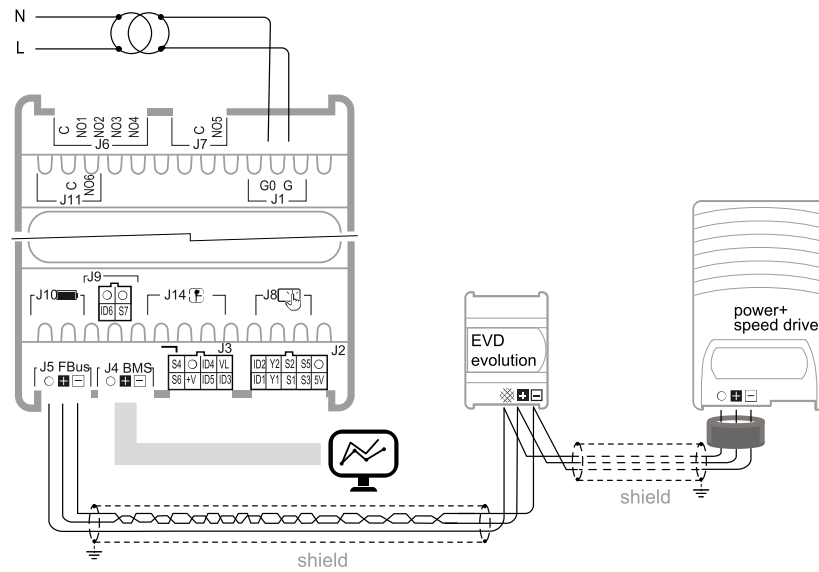

Fig.2.l

ⓘ **Note:** in the two-circuit version, the EVD Evolution driver, if used, must be connected to the FieldBus port (terminal J5) on the slave controller.

2.10 Positioning of probes/compon ents

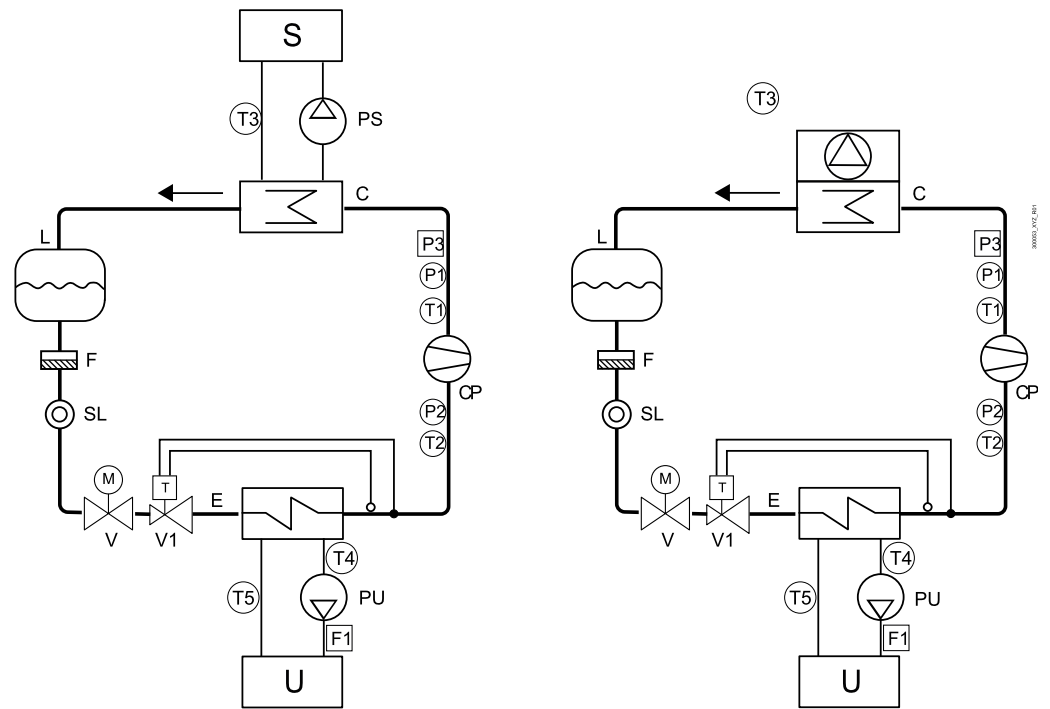

Fig.2.m: water-cooled unit (left) and air-cooled unit (right)

Ref.	Description
S	Source
U	User
E	Evaporator
F	Filter-drier
L	Liquid receiver
CP	Compressor
C	Condenser
SL	Liquid sightglass
P1	Condensing pressure probe
V	Solenoid valve
V1	Thermostatic expansion valve

Ref.	Description
PU	User pump
PS	Source pump
P2	Evaporation pressure probe
T1	Discharge temperature probe
T2	Suction temperature probe
P3	High pressure switch
T3	Return temperature sensor (from) source/outside
F1	User pump flow switch
T4	Water delivery temperature (to) user
T5	Water return temperature (from) user

Tab.2.b

2.11 Functional diagrams

2.11.1 Chillers, On/Off compressors and thermostatic expansion valve

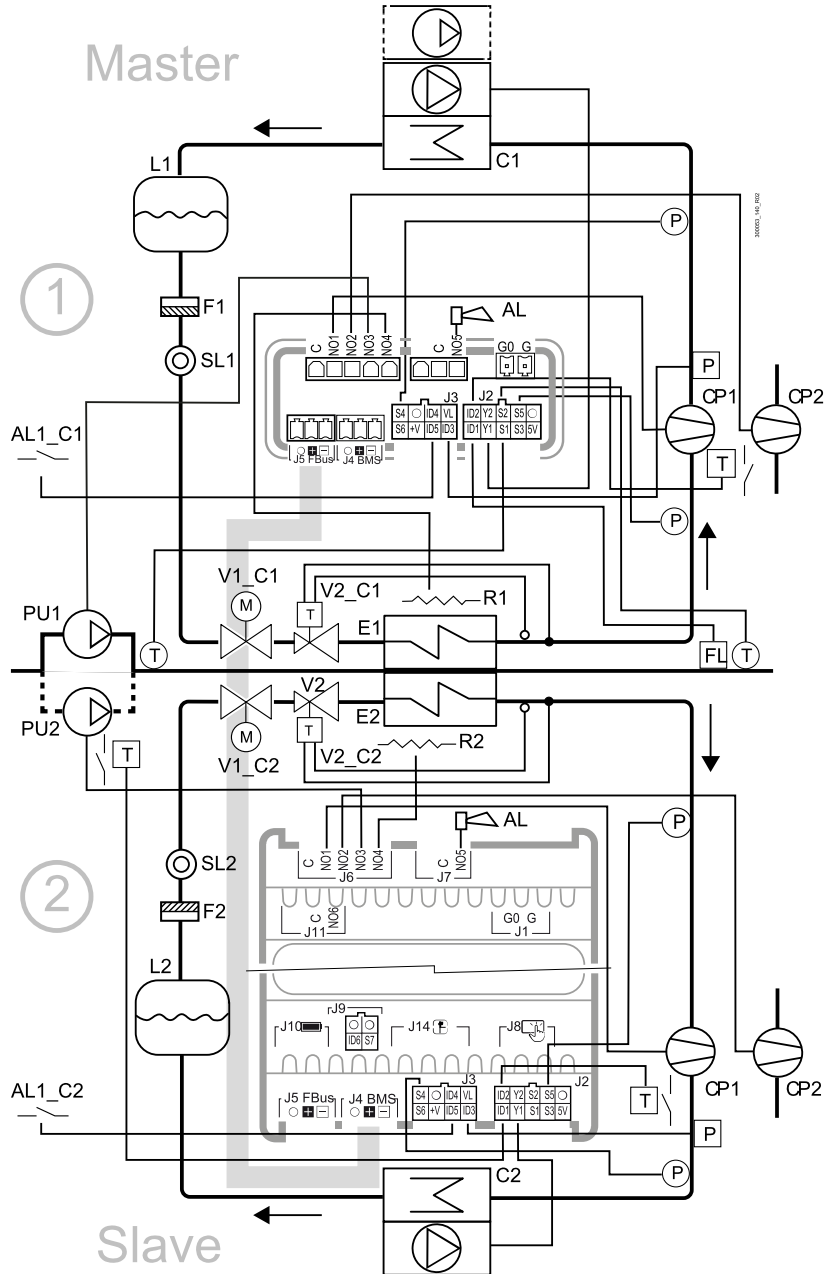

Fig.2.n

Ref.	Description	Ref.	Description	Ref.	Description
C1/C2	Condenser 1/2	SL1/2	Liquid sightglass 1/2	R1/2	Frost protection heater 1/2
E1/E2	Evaporator 1/2	F1/2	Filter-drier 1/2	P	Pressure probe/pressure switch
V1_C1	Solenoid valve circuit 1	FL	Flow switch	T	Temperature probe/thermostat
V1_C2	Solenoid valve circuit 2	CP1/2	Compressor 1/2	AL	Alarm
V2_C1	Thermostatic expansion				

Ref.	Description	Ref.	Description	Ref.	Description
	valve circuit 1	PU1/2	User pump 1/2	AL1_C1/2	Remote alarm circuit 1/2
V2_C2	Thermostatic expansion valve circuit 2	L1/2	Liquid receiver 1/2		

Tab.2.c

Analogue inputs - Master circuit 1

Ref.	Description	Type	Configuration parameters
S1	Return temperature from user	NTC	--
S2	Delivery temperature to user	NTC	--
S3	Not present	-	Hc00
S4	Condensing pressure	0-5V	Hc01; Hc02; C040; C041; C042
S5	Evaporation pressure	0-5V	Hc01; C037; C038; C039
S6	Not present	-	Hc03; U025; U026; U027

Analogue inputs - Slave circuit 2

Ref.	Description	Type	Configuration parameters
S1	Not present	-	--
S2	Not present	-	--
S3	Not present	-	Hc00
S4	Condensing pressure	0-5V	Hc01; Hc02; C040; C041; C042
S5	Evaporation pressure	0-5V	Hc01; C037; C038; C039
S6	Not present	-	Hc05; U025; U026; U027

Note:

- probes S1 and S2 are not configurable, for the other probes, see the parameter table;
- the discharge temperature probe is automatically assigned type NTC-HT.

Digital inputs - Master circuit 1

Ref.	Description	Configuration parameters
ID1	User pump flow switch	U060
ID2	Compressor 1 overload	C035
ID3	High pressure switch	C034
ID4	Not present	Hc06; C035; U059; U058; U062; U057; U061
ID5	Remote alarm	Hc07; C035; U059; U058; U062; U057; U061

Digital inputs - Slave circuit 2

Ref.	Description	Configuration parameters
ID1	Pump 2 overload	U061
ID2	Compressor 1 overload	C035
ID3	High pressure switch	C034
ID4	Not present	Hc09; C035; U059; U058;

Ref.	Description	Configuration parameters
		U062; U057; U061
ID5	Remote alarm	Hc10; C035; U059; U058; U062; U057; U061
ID6	Not used	--

Digital outputs - Master circuit 1

Ref.	Description	Configuration parameters
C-NO1	Compressor 1	C036
C-NO2	Compressor 2	C036
C-NO3	User pump 1	U063
C-NO4	Frost protection heater (*)	U066; S063; U065
C5-NO5	Alarm	U064

Digital outputs - Slave circuit 2

Ref.	Description	Configuration parameters
C-NO1	Compressor 1	C036
C-NO2	Compressor 2	C036
C-NO3	User pump 2	U063
C-NO4	Frost protection heater (*)	U066; S063; U065
C5-NO5	Alarm	U064
C6-NO6	Not used	--

 **Note:** (*) the configuration of the output depends on the type of unit: heat pump (reverse-cycle) => reversing valve; Chiller with free cooling (master only) => FC valve; otherwise => Frost protection heater.

Analogue outputs - Master circuit 1

Ref.	Description	Type	Notes
Y1	Modulating/ On-Off fan	0-10V	FCS1*0 /CONVONOFF
Y2	Not used	0-10V	

Analogue outputs - Slave circuit 2

Ref.	Description	Type	Notes
Y1	Modulating/ On-Off fan	0-10V	FCS1*0 /CONVONOFF
Y2	Not used	0-10V	

2.11.2 Chillers, On/Off compressors with free cooling and thermostatic expansion valve

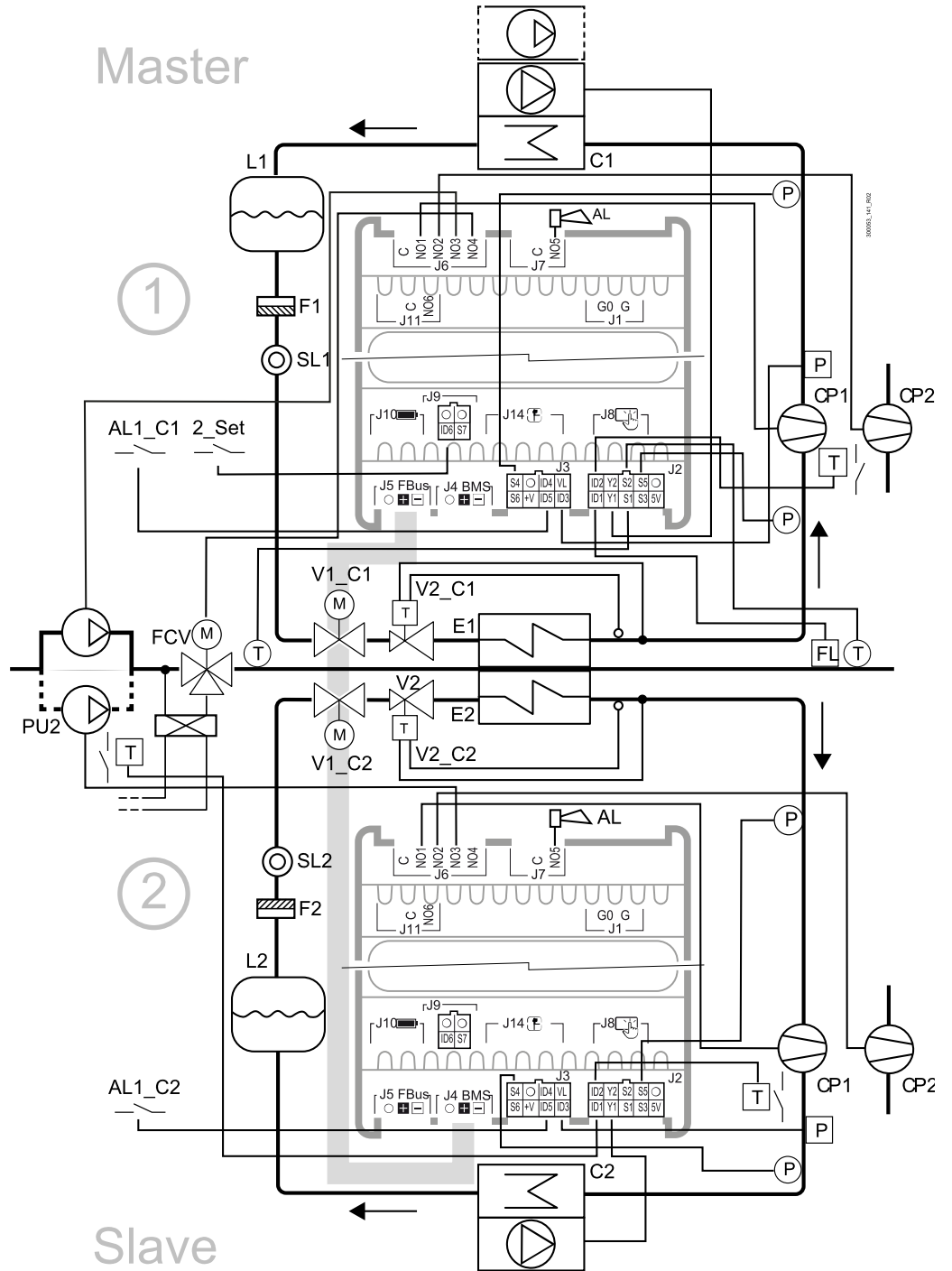

Fig.2.o

Ref.	Description	Ref.	Description	Ref.	Description
C1/C2	Condenser 1/2	SL1/2	Liquid sightglass 1/2	FCV	Free cooling valve
E1/E2	Evaporator 1/2	F1/2	Filter-drier 1/2	P	Pressure probe/pressure switch
V1_C1	Solenoid valve circuit 1	FL	Flow switch	T	Temperature probe/thermostat
V1_C2	Solenoid valve circuit 2	CP1/2	Compressor 1/2	AL	Alarm
V2_C1	Thermostatic expansion valve circuit 1	PU1/2	User pump 1/2	AL1_C1/2	Remote alarm circuit 1/2
V2_C2	Thermostatic expansion valve circuit 2	L1/2	Liquid receiver 1/2	2_Set	2nd set point

Tab.2.d

Analogue inputs - Master circuit 1

Ref.	Description	Type	Configuration parameters
S1	Return temperature from user	NTC	--
S2	Delivery temperature to user	NTC	--
S3	Not present	-	Hc00
S4	Condensing pressure	0-5V	Hc01; Hc02; C040; C041; C042
S5	Evaporation pressure	0-5V	Hc01; C037; C038; C039
S6	Not present	-	Hc03; U025; U026; U027

Analogue inputs - Slave circuit 1

Ref.	Description	Type	Configuration parameters
S1	Not present	-	--
S2	Not present	-	--
S3	Not present	-	Hc00
S4	Condensing pressure	0-5V	Hc01; Hc02; C040; C041; C042
S5	Evaporation pressure	0-5V	Hc01; C037; C038; C039
S6	Not present	-	Hc05; U025; U026; U027

Note:

- probes S1 and S2 are not configurable, for the other probes, see the parameter table;
- the discharge temperature probe is automatically assigned type NTC-HT.

Digital inputs - Master circuit 1

Ref.	Description	Configuration parameters
ID1	User pump flow switch	U060
ID2	Compressor 1 overload	C035
ID3	High pressure switch	C034
ID4	Not present	Hc06; C035; U059; U058; U062; U057; U061
ID5	Remote alarm	Hc07; C035; U059; U058; U062; U057; U061
ID6	2nd set point	HC08; C035; U059; U058; U062; U057; U061

Digital inputs - Slave circuit 2

Ref.	Description	Configuration parameters
ID1	Pump 2 overload	U061
ID2	Compressor 1 overload	C035
ID3	High pressure switch	C034
ID4	Not present	Hc09; C035; U059; U058; U062; U057; U061
ID5	Remote alarm	Hc10; C035; U059; U058; U062; U057; U061
ID6	Not used	--

Digital outputs - Master circuit 1

Ref.	Description	Configuration parameters
C-NO1	Compressor 1	C036
C-NO2	Compressor 2	C036
C-NO3	User pump 1	U063
C-NO4	Free cooling valve (*)	U066; S063; U065
C5-NO5	Alarm	U064
C6-NO6	Not used	--

Digital outputs - Slave circuit 2

Ref.	Description	Configuration parameters
C-NO1	Compressor 1	C036
C-NO2	Compressor 2	C036
C-NO3	User pump 2	U063
C-NO4	Not used	U066; S063; U065
C5-NO5	Alarm	U064
C6-NO6	Not used	--

➡ **Note:** (*) the configuration of the output depends on the type of unit: heat pump (reverse-cycle) => reversing valve; Chiller with free cooling => FC valve; otherwise => Frost protection heater.

Analogue outputs - Master circuit 1

Ref.	Description	Type	Notes
Y1	Modulating/ On-Off fan	0-10V	FCS1*0 /CONVONOFF
Y2	Not used	0-10V	

Analogue outputs - Slave circuit 2

Ref.	Description	Type	Notes
Y1	Modulating/ On-Off fan	0-10V	FCS1*0 /CONVONOFF
Y2	Not used	0-10V	

2.11.3 Chillers/heat pumps, On/Off compressors and bipolar ExV expansion valve

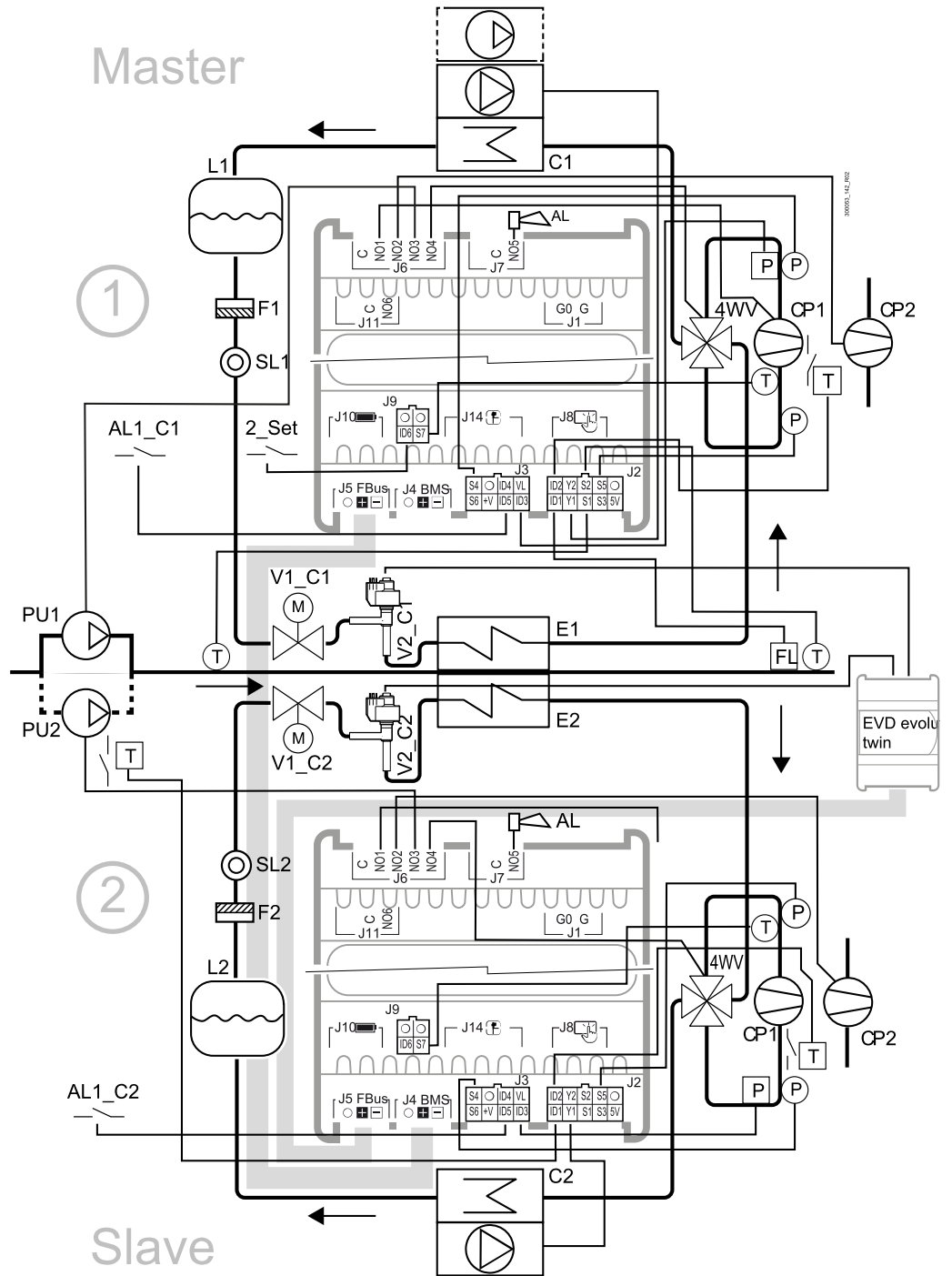

Fig.2.p

Ref.	Description	Ref.	Description	Ref.	Description
C1/C2	Condenser 1/2	SL1/2	Liquid sightglass 1/2	4WV	Reversing valve
E1/E2	Evaporator 1/2	F1/2	Filter-drier 1/2	P	Pressure probe/pressure switch

Ref.	Description	Ref.	Description	Ref.	Description
V1_C1	Solenoid valve circuit 1	FL	Flow switch	T	Temperature probe/thermostat
V1_C2	Solenoid valve circuit 2	CP1/2	Compressor 1/2	AL	Alarm
V2_C1	Electronic expansion valve circuit 1	PU1/2	User pump 1/2	AL1_C1/2	Remote alarm circuit 1/2
V2_C2	Electronic expansion valve circuit 2	L1/2	Liquid receiver 1/2	2_Set	2nd set point

Tab.2.e

Analogue inputs - Master circuit 1

Ref.	Description	Type	Configuration parameters
S1	Return temperature from user	NTC	--
S2	Delivery temperature to user	NTC	--
S3	Not present	-	Hc00
S4	Condensing pressure	0-5V	Hc01; Hc02; C040; 041; C042
S5	Evaporation pressure	0-5V	Hc01; C037; C038; C039
S6	Not present	-	Hc03; U025; U026; U027
S7	Suction temperature	NTC	Hc04

Analogue inputs - Slave circuit 1

Ref.	Description	Type	Configuration parameters
S1	Not present	-	--
S2	Not present	-	--
S3	Not present	-	Hc00
S4	Condensing pressure	0-5V	Hc01; Hc02; C040; C041; C042
S5	Evaporation pressure	0-5V	Hc01; C037; C038; C039
S6	Not present	-	Hc05; U025; U026; U027
S7	Suction temperature	NTC	Hc04

Note:

- probes S1 and S2 are not configurable, for the other probes, see the parameter table;
- the discharge temperature probe is automatically assigned type NTC-HT.

Digital inputs - Master circuit 1

Ref.	Description	Configuration parameters
ID1	User pump flow switch	U060
ID2	Compressor 1 overload	C035
ID3	High pressure switch	C034
ID4	Not present	Hc06; C035; U059; U058; U062; U057; U061
ID5	Remote alarm	Hc07; C035; U059; U058; U062; U057; U061
ID6	2nd set point	HC08; C035; U059; U058; U062; U057; U061

Digital inputs - Slave circuit 2

Ref.	Description	Configuration parameters
ID1	Pump 2 overload	U061
ID2	Compressor 1 overload	C035
ID3	High pressure switch	C034
ID4	Not present	Hc09; C035; U059; U058; U062; U057; U061
ID5	Remote alarm	Hc10; C035; U059; U058; U062; U057; U061
ID6	Not used	--

Digital outputs - Master circuit 1

Ref.	Description	Configuration parameters
C-NO1	Compressor 1	C036
C-NO2	Compressor 2	C036
C-NO3	User pump 1	U063
C-NO4	Reversing valve	U066; S063; U065
C5-NO5	Alarm	U064
C6-NO6	Not used	--

Digital outputs - Slave circuit 2

Ref.	Description	Configuration parameters
C-NO1	Compressor 1	C036
C-NO2	Compressor 2	C036
C-NO3	User pump 2	U063
C-NO4	Reversing valve	U066; S063; U065
C5-NO5	Alarm	U064
C6-NO6	Not used	--

 **Note:** (*) the configuration of the output depends on the type of unit: heat pump (reverse-cycle) => reversing valve; Chiller with free cooling => FC valve; otherwise => Frost protection heater.

Analogue outputs - Master circuit 1

Ref.	Description	Type	Notes
Y1	Modulating/ On-Off fan	0-10V	FCS1*0 /CONVONOFF
Y2	Not used	0-10V	

Analogue outputs - Slave circuit 2

Ref.	Description	Type	Notes
Y1	Modulating/ On-Off fan	0-10V	FCS1*0 /CONVONOFF
Y2	Not used	0-10V	

2.11.4 Chillers, On/Off compressors and unipolar ExV expansion valve

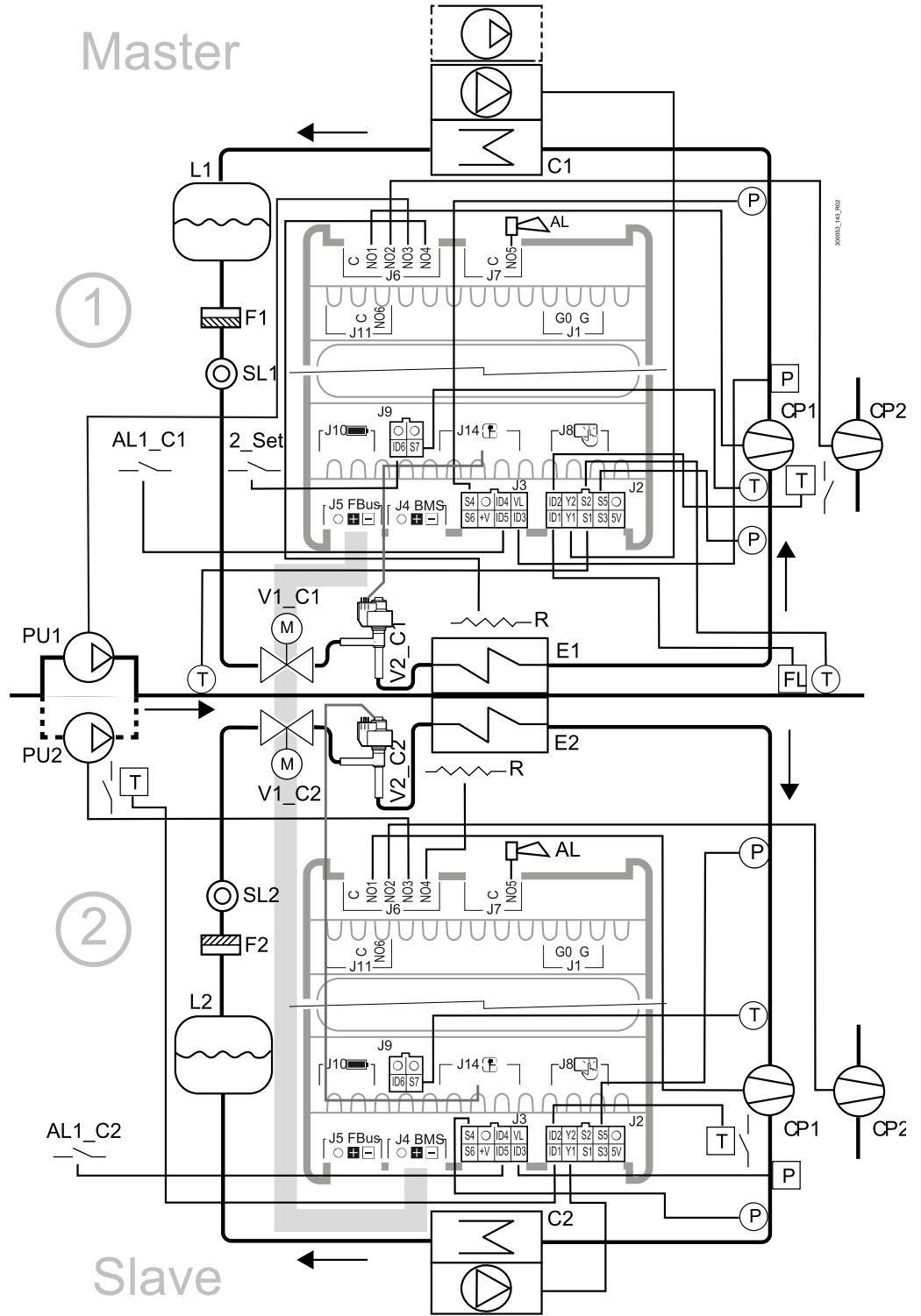

Fig.2.q

Ref.	Description	Ref.	Description	Ref.	Description
C1/C2	Condenser 1/2	SL1/2	Liquid sightglass 1/2	R1/2	Frost protection heater
E1/E2	Evaporator 1/2	F1/2	Filter-drier 1/2	P	Pressure probe/pressure switch
V1_C1	Solenoid valve circuit 1	FL	Flow switch	T	Temperature probe/thermostat
V1_C2	Solenoid valve circuit 2	CP1/2	Compressor 1/2	AL	Alarm
V2_C1	Electronic expansion valve circuit 1	PU1/2	User pump 1/2	AL1_C1/2	Remote alarm circuit 1/2
V2_C2	Electronic expansion valve circuit 2	L1/2	Liquid receiver 1/2	2_Set	2nd set point

Tab.2f

Analogue inputs - Master circuit 1

Ref.	Description	Type	Configuration parameters
S1	Return temperature from user	NTC	--
S2	Delivery temperature to user	NTC	--
S3	Not present	-	Hc00
S4	Condensing pressure	0-5V	Hc01; Hc02; C040; 041; C042
S5	Evaporation pressure	0-5V	Hc01; C037; C038; C039
S6	Not present	-	Hc03; U025; U026; U027
S7	Suction temperature	NTC	Hc04

Analogue inputs - Slave circuit 2

Ref.	Description	Type	Configuration parameters
S1	Not present	-	--
S2	Not present	-	--
S3	Not present	-	Hc00
S4	Condensing pressure	0-5V	Hc01; Hc02; C040; C041; C042
S5	Evaporation pressure	0-5V	Hc01; C037; C038; C039
S6	Not present	-	Hc05; U025; U026; U027
S7	Suction temperature	NTC	Hc04

Note:

- probes S1 and S2 are not configurable, for the other probes, see the parameter table;
- the discharge temperature probe is automatically assigned type NTC-HT.

Digital inputs - Master circuit 1

Ref.	Description	Configuration parameters
ID1	User pump flow switch	U060
ID2	Compressor 1 overload	C035
ID3	High pressure switch	C034
ID4	Not present	Hc06; C035; U059; U058; U062; U057; U061
ID5	Remote alarm	Hc07; C035; U059; U058; U062; U057; U061
ID6	2nd set point	HC08; C035; U059; U058; U062; U057;

Ref.	Description	Configuration parameters
		U061

Digital inputs - Slave circuit 2

Ref.	Description	Configuration parameters
ID1	Pump 2 overload	U061
ID2	Compressor 1 overload	C035
ID3	High pressure switch	C034
ID4	Not present	Hc09; C035; U059; U058; U062; U057; U061
ID5	Remote alarm	Hc10; C035; U059; U058; U062; U057; U061
ID6	Not used	--

Digital outputs - Master circuit 1

Ref.	Description	Configuration parameters
C-NO1	Compressor 1	C036
C-NO2	Compressor 2	C036
C-NO3	User pump 1	U063
C-NO4	Frost protection heater (*)	U066; S063; U065
C5-NO5	Alarm	U064
C5-NO6	Not used	

Digital outputs - Slave circuit 2

Ref.	Description	Configuration parameters
C-NO1	Compressor 1	C036
C-NO2	Compressor 2	C036
C-NO3	User pump 2	U063
C-NO4	Frost protection heater (*)	U066; S063; U065
C5-NO5	Alarm	U064
C6-NO6	Not used	--

➔ **Note:** (*) the configuration of the output depends on the type of unit: heat pump (reverse-cycle) => reversing valve; Chiller with free cooling (master only) => FC valve; otherwise => Frost protection heater.

Analogue outputs - Master circuit 1

Ref.	Description	Type	Notes
Y1	Modulating/ On-Off fan	0-10V	FCS1*0 /CONVONOFF
Y2	Not used	0-10V	

Analogue outputs - Slave circuit 2

Ref.	Description	Type	Notes
Y1	Modulating/ On-Off fan	0-10V	FCS1*0 /CONVONOFF
Y2	Not used	0-10V	

2.11.5 Chillers/heat pumps, BLDC+On/Off compressors and bipolar ExV expansion valve

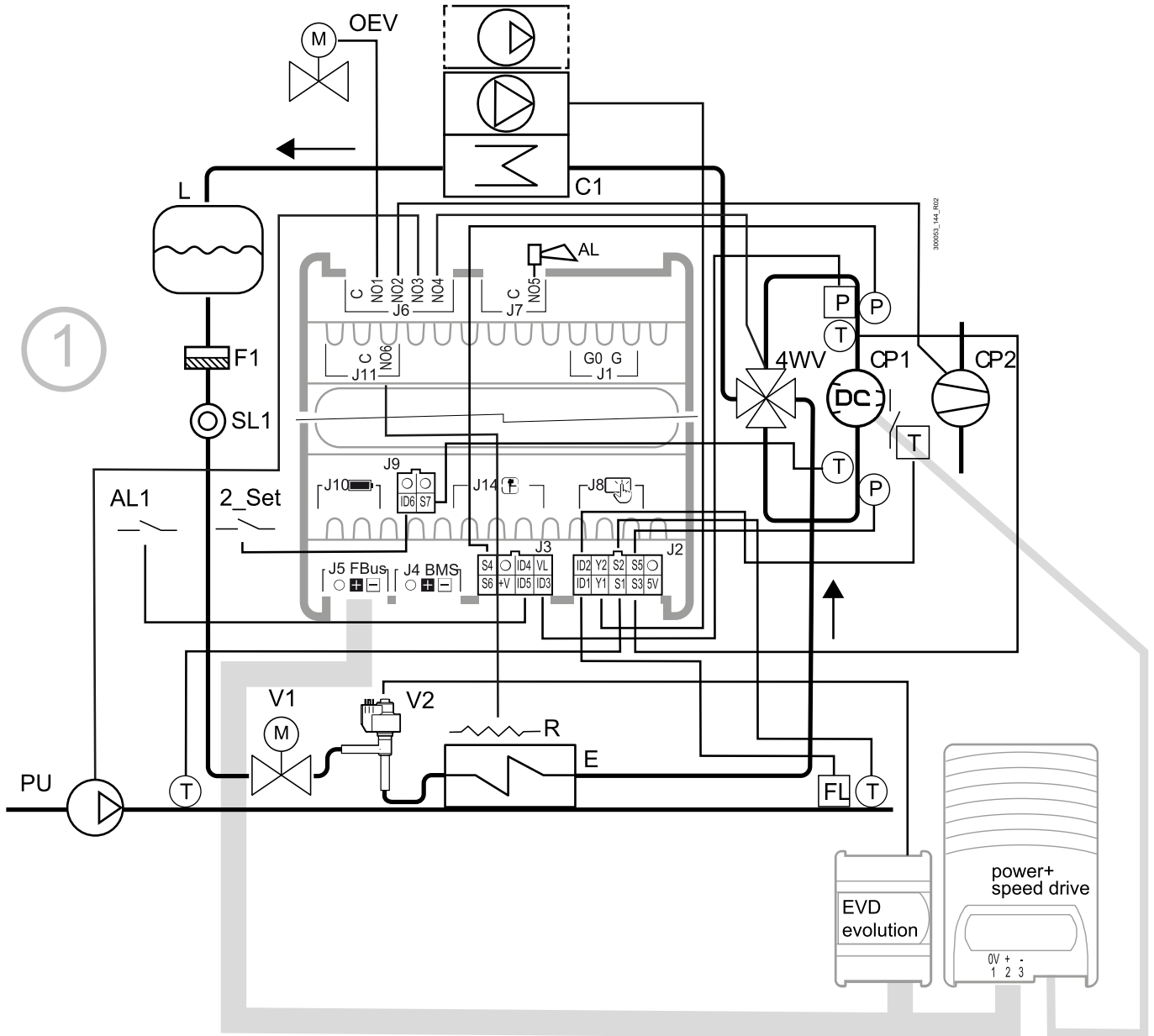

Fig.2.r

Ref.	Description	Ref.	Description	Ref.	Description
C	Condenser	FL	Flow switch	4WV	4-way reversing valve
E	Evaporator	CP1/2	Compressor 1/2	P	Pressure probe/pressure switch
V1	Solenoid valve	PU	User pump	T	Temperature probe/thermostat
V2	Electronic expansion valve	L	Liquid receiver	AL	Alarm
SL	Liquid sightglass	OEV	Oil equalisation valve	AL1	Remote alarm
F1	Filter-drier			2_Set	2nd set point

Tab.2g

Analogue inputs

Ref.	Description	Type	Configuration parameters
S1	Return temperature from user	NTC	--
S2	Delivery temperature to user	NTC	--
S3	Discharge temperature	-	Hc00
S4	Condensing pressure	0-5V	Hc01; Hc02; C040; 041; C042
S5	Evaporation pressure	0-5V	Hc01; C037; C038; C039
S6	Not present	-	Hc03; U025; U026; U027
S7	Suction temperature	NTC	Hc04

Note:

- probes S1 and S2 are not configurable, for the other probes, see the parameter table;
- the discharge temperature probe is automatically assigned type NTC-HT.

Digital inputs

Ref.	Description	Configuration parameters
ID1	User pump flow switch	U060
ID2	Compressor 1 overload	C035
ID3	High pressure switch	C034
ID4	Not present	Hc06; C035; U059; U058; U062; U057; U061
ID5	Remote alarm	Hc07; C035; U059; U058; U062; U057; U061
ID6	2nd set point	HC08; C035; U059; U058; U062; U057; U061

Digital outputs

Ref.	Description	Configuration parameters
C-NO1	Oil equalisation valve (tandem compressors only)	P017
C-NO2	Compressor 2	C036
C-NO3	User pump 1	U063
C-NO4	Reversing valve (*)	U066; S063; U065
C-NO5	Alarm	U064
C-NO6	Frost protection heater	Hc12

Note:

- BLDC compressor driven by Power+ speed drive.
- (*) the configuration of the output depends on the type of unit: heat pump (reverse-cycle) => reversing valve; Chiller with free cooling (master only) => FC valve; otherwise => Frost protection heater.

Analogue outputs

Ref.	Description	Type	Notes
Y1	Modulating/ On-Off fan	0-10V	FCS1*0 /CONVONOFF
Y2	Not used	0-10V	

2.11.6 Chillers/heat pumps, BLDC+On/Off compressors and bipolar ExV expansion valve

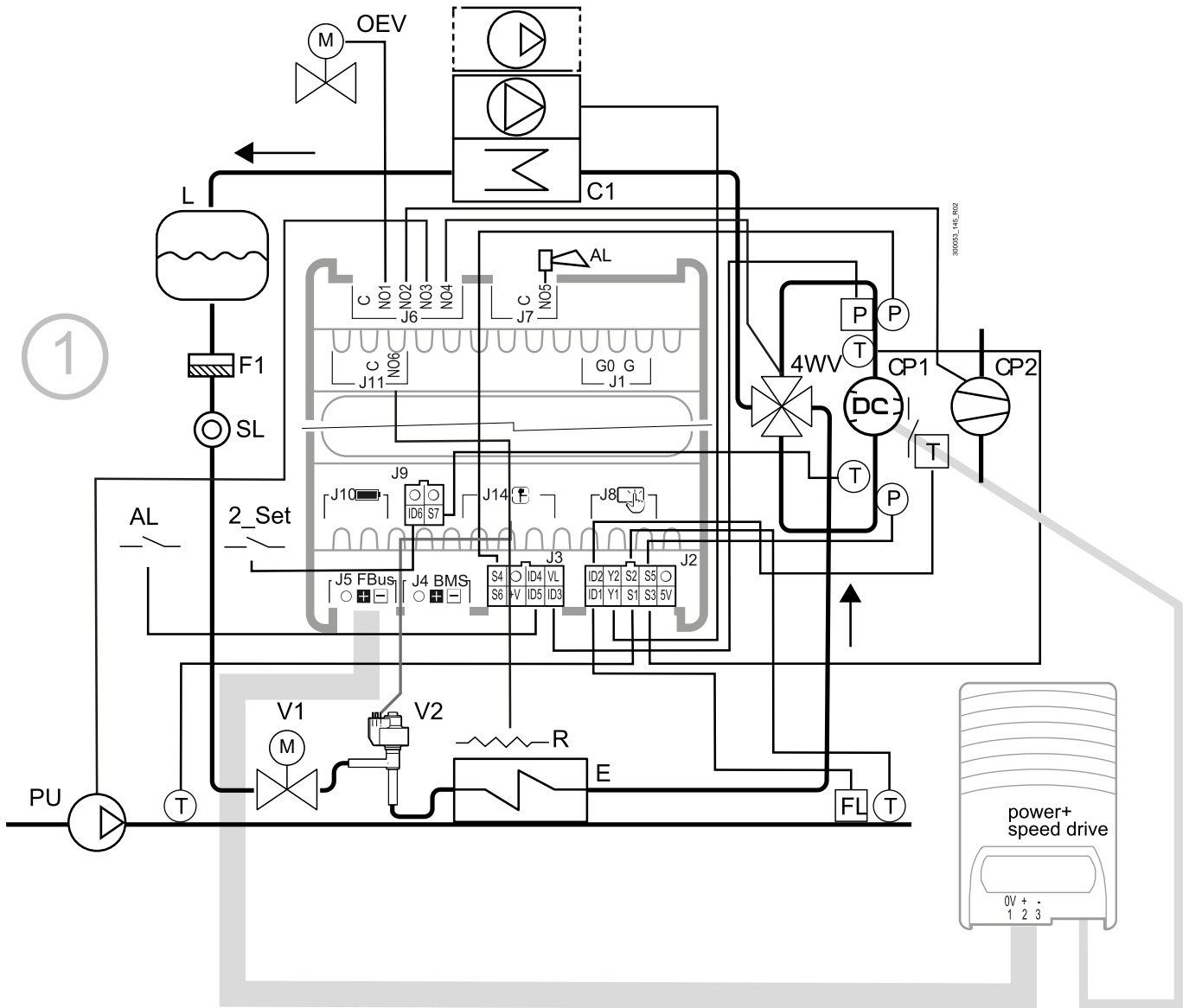

Fig.2.s

Ref.	Description	Ref.	Description	Ref.	Description
C	Condenser	FL	Flow switch	4WV	4-way reversing valve
E	Evaporator	CP1/2	Compressor 1/2	P	Pressure probe/pressure switch
V1	Solenoid valve	PU	User pump	T	Temperature probe/thermostat
V2	Electronic expansion valve	L	Liquid receiver	AL	Alarm
SL	Liquid sightglass	OEV	Oil equalisation valve	AL1	Remote alarm
F1	Filter-drier			2_Set	2nd set point

Tab.2.h

Analogue inputs

Ref.	Description	Type	Configuration parameters
S1	Return temperature from user	NTC	--
S2	Delivery temperature to user	NTC	--
S3	Discharge temperature	-	Hc00
S4	Condensing pressure	0-5V	Hc01; Hc02; C040; 041; C042
S5	Evaporation pressure	0-5V	Hc01; C037; C038; C039
S6	Not present	-	Hc03; U025; U026; U027
S7	Suction temperature	NTC	Hc04

Note:

- probes S1 and S2 are not configurable, for the other probes, see the parameter table;
- the discharge temperature probe is automatically assigned type NTC-HT.

Digital inputs

Ref.	Description	Configuration parameters
ID1	User pump flow switch	U060
ID2	Compressor 1 overload	C035
ID3	High pressure switch	C034
ID4	Not present	Hc06; C035; U059; U058; U062; U057; U061
ID5	Remote alarm	Hc07; C035; U059; U058; U062; U057; U061
ID6	2nd set point	HC08; C035; U059; U058; U062; U057; U061

Digital outputs

Ref.	Description	Configuration parameters
C-NO1	Oil equalisation valve (tandem compressors only)	P017
C-NO2	Compressor 2	C036
C-NO3	User pump 1	U063
C-NO4	Reversing valve (*)	U066; S063; U065
C-NO5	Alarm	U064
C-NO6	Frost protection heater	Hc12

- Note:** (*) the configuration of the output depends on the type of unit: heat pump (reverse-cycle) => reversing valve; Chiller with free cooling (master only) => FC valve; otherwise => Frost protection heater.

Analogue outputs

Ref.	Description	Type	Notes
Y1	Modulating/ On-Off fan	0-10V	FCS1*0 /CONVONOFF
Y2	Not used	0-10V	

3. Commissioning

3.1 APPLICA app

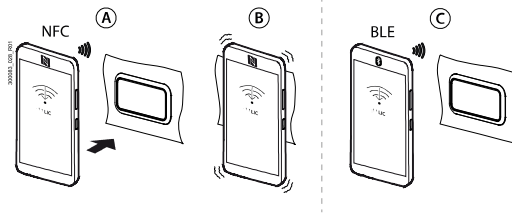

The "Applica" app can be used to configure the controller from a mobile device (smartphone, tablet), via NFC (Near Field Communication) and Bluetooth (BLE). Users can both configure the commissioning parameters and set groups of preset parameters according to specific needs (recipes).

➔ **Note:** before commissioning the unit, you first need to access KSA: if you do not yet have an account, select "Create account" and fill out the registration form, following the instructions provided.

Preparing for operation

1. Access KSA, "Software & Support", "µChiller" section.
2. Select the "Configurations" folder.
3. For µChiller Standard and Enhanced models (with On/Off compressor), select the "Refrigerants" section and then the refrigerant charged on the unit;
4. Import the downloaded configuration onto your mobile device.
5. (NOTE: the BLDC compressor configuration must be performed with the unit OFF and the "Crankcase heater" function disabled (par. P034 = 0). For High Efficiency models (HE, with BLDC compressor), first import the BLDC compressor configuration, selecting the "BLDC Compressors" section, and then set the brand and model of compressor installed on the unit.
6. Import the downloaded configuration onto your mobile device (this already includes the refrigerant settings).

Configuration procedure

Once the Carel "Applica" app has been installed and opened (see the paragraph "Mobile device", proceed as follows:

7. For NFC devices (A), move the mobile device near to the µChiller user terminal (the position of the NFC antenna on the mobile device must be identified in order to place it over the display): wait for the signal that the device has been read (B).
8. For Bluetooth devices (C), select the "SCAN BLUETOOTH" option, then choose the device from the list.
9. Load the configuration by clicking the + icon in the "Configurations" bar

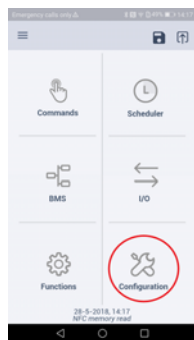

Fig.3.a

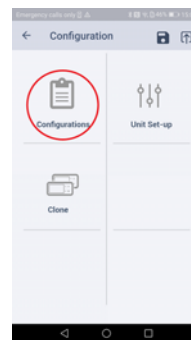

Fig.3.b

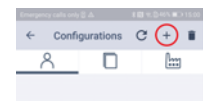

Fig.3.c

10. the "open from" dialogue box will be shown:

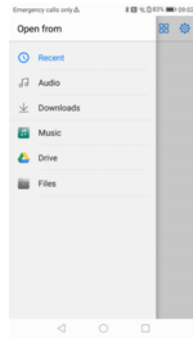

Fig.3.d

11. Select the desired option to load the configuration (the screen in the figure shows the files available on the mobile device and therefore depends on the model of mobile device and the file manager application installed).
12. Apply the selected configuration via NFC or Bluetooth on μ Chiller.
13. Select the "Unit set-up" menu to configure the unit completely (use PREV / NEXT to scroll through all the configuration parameter pages).

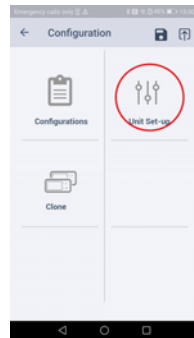

Fig.3.e



Fig.3.f

3.1.1 Unit set-up parameter list

Par.	Description	Def.	Min.	Max.	UOM
U077	Type of unit (0=CH; 1=HP; 2=CH/HP)	0	0	2	-
S068	Type of unit (0=Air/Water, 1=Water/Water)	0	0	1	-
U076	Number of user pumps	1	1	2	-
C046	No. of unit circuits	1	1	2	-
C047	Type of compressors used (0=1 On/Off; 1=2 On/Off; 2=1 BLDC; 3=1 BLDC+On/Off)	0	0	1	-
S065	Type of source fan (0/1=Modulating/ON-OFF)	0	0	1	-
S064	Type of source air circuit (0=Independent; 1=Common)	0	0	1	-
E047	ExV driver (0=Disabled; 1=Built-in; 2=EVD Evolution)	0	0	2	-
E046	EVD Evolution: valve (1=CAREL ExV, ...) (*) (*) see EVD Evolution manual for the complete list of selectable valves	1	1	24	-
E020	MOP in cooling: threshold	30.0	-60.0	200.0	°C
E022	MOP in heating: threshold	20.0	-60.0	200.0	°C
C017	Max high pressure threshold (HP)	65.0	0.0	999.9	°C
C018	Min low pressure threshold (LP)	0.2	-99.9	99.9	bar
U068	Free cooling: enable (0/1=no/yes)	0	0	1	-
U071	Design free cooling delta T	8.0	0.0	99.9	K
U074	Free cooling type (0=Air; 1=Remote coil; 2=Water)	0	0	2	-
Hc02	Enable S4 (0/1=no/yes)	1	0	1	-
Hc06	ID4 configuration (0=Not used; 1=Compr. 2 circuit 1 overload; 2=Remote ON/OFF; 3=Cooling/Heating; 4=2nd Set point; 5=Remote alarm; 6=User pump 1 overload)	0	0	6	-

Par.	Description	Def.	Min.	Max.	UOM
Hc07	ID5 configuration (0=Not used; 1=Comp. 2 circuit 1 overload; 2=Remote ON/OFF; 3=Cooling/Heating; 4=2nd Set point; 5=Remote alarm; 6=User pump 1 overload)	5	0	6	
Hc03	S6 configuration S6 (0=Not used; 1=Remote set point; 2=Source temperature; 3=Reserved)	0	0	3	
Hc09	ID4 configuration (Slave) (0=Not used; 1=Comp. 2 circuit 2 overload; 2=Remote ON/OFF; 3=Cooling/Heating; 4=2nd Set point; 5=User pump 1 overload)	0	0	5	
Hc10	ID5 configuration ID5 (Slave) (0=Not used; 1=Comp. 2 circuit 2 overload; 2=Remote ON/OFF; 3=Cooling/Heating; 4=2nd Set point; 5=User pump 1 overload)	0	0	5	
U061	User pump overload protector: input logic (0/1=NC/NO)	0	0	1	-
U065	Free cooling valve: output logic (0/1=NO/NC)	0	0	1	-
S063	Reversing valve: output logic (0/1=NO/NC)	0	0	1	-
S054	4-way valve: pressure differential for reversing	3.0	0.0	999.9	bar
S053	Defrost synchronisation (0=Independent, 1=Separate, 2=Simultaneous)	0	0	2	-
C037	Suction pressure: probe type (0=0-5V; 1=4-20mA)	0	0	1	-
C038	Suction pressure probe: min value	0.0	-1.0	99.9	bar
C039	Suction pressure probe: max value	17.3	0.0	99.9	bar
C040	Discharge pressure: probe type (0=0-5V; 1=4-20mA)	0	0	1	-
C041	Discharge pressure probe: min value	0.0	-1.0	99.9	bar
C042	Discharge pressure probe: max value	45.0	0.0	99.9	bar
U006	Cooling set point: minimum limit	5.0	-99.9	999.9	°C
U007	Cooling set point: maximum limit	20.0	-99.9	999.9	°C
U008	Heating set point: minimum limit	30.0	0.0	999.9	°C
U009	Heating set point: maximum limit	45.0	0.0	999.9	°C

Tab.3.a

3.1.2 Applica: date and time setting

Applica includes a feature for setting the date and time on µChiller in just one simple step, copying the values from the mobile device

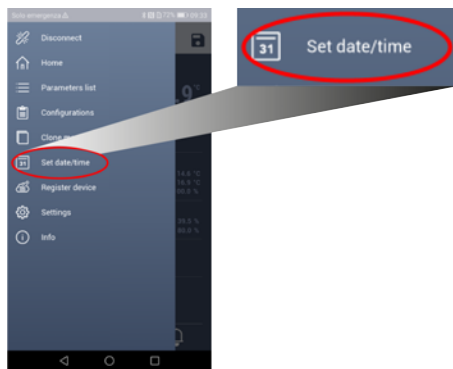

Fig.3.g

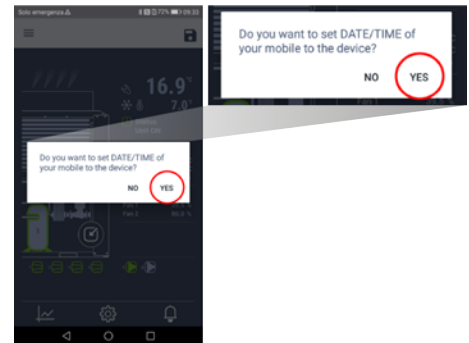

Fig.3.h

Procedure:

1. open Applica on the mobile device;
2. access the controller via NFC or Bluetooth, entering your profile credentials;
3. access the menu on the command bar at the top left;
4. select "set date/time":
5. confirm;
6. with an NFC connection, move the device near to the user terminal to write the copied values.

➔ **Note:** with a Bluetooth connection, the values are copied on confirmation.

3.1.3 Applica: copy configuration

Applica includes a "Clone" feature to acquire the configuration from one unit and replicate it "one-for-one" to other units.

Procedure:

1. open Applica on the mobile device;
2. access the controller via NFC or Bluetooth, using the "Service" or "Manufacturer" profile credentials;
3. follow the path "Configurations/Clone";
4. enter a name to describe the configuration being saved;
5. with an NFC connection: move the device near to the display terminal on the μ Chiller that the configuration is being copied from; once the message shows the configuration has been acquired, this is saved to the smartphone's memory, available via icon 2 (see the following figure);
6. select the saved configuration; (with an NFC connection) move the device near to the display terminal on the μ Chiller that the same configuration is being applied to;
7. confirm and wait for the confirmation message.

Note: with a Bluetooth connection the configuration is saved/applied on confirmation.

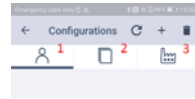

Fig.3.i

With reference to the previous figure, tapping icon:

- 1: accesses the configurations saved by the user;
- 2: accesses the saved clones;
- 3: accesses the configurations prepared by Carel.

Commissioning software (Applica Desktop)

Applica Desktop is a program intended for manufacturers and installers of units fitted with the μ Chiller controller. It can be downloaded from ksa.carel.com.

The Applica Desktop offers the possibility to:

- access the controller using the assigned profile;
- create configurations;
- apply configurations;
- clone a unit configuration, i.e. copy all of the unit's parameter values;
- complete the commissioning procedure;
- troubleshoot any problems on the unit.

Note:

- Applica Desktop can be used as an alternative to the Applica app, and requires an internet connection;
- for the physical connection to the BMS port on μ Chiller, use the USB/RS485 converter P/N CVSTDUMORO.

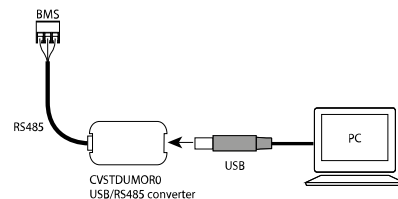

Fig.3.j

Preparing for operation

1. Access KSA, "Software & Support", " μ Chiller" section.
2. Select the "Configurations" folder.

3.2 Applica Desktop

3. For μ Chiller Standard and Enhanced models (with On/Off compressor), select the "Refrigerants" section and then the refrigerant charged on the unit.
4. (NOTE: the BLDC compressor configuration must be performed with the unit OFF and the "Crankcase heater" function disabled (par. P034 = 0). For High Efficiency models (HE, with BLDC compressor), first import the BLDC compressor configuration, selecting the "BLDC Compressors" section, and then set the brand and model of compressor installed on the unit.

Configuration procedure

1. Connect to the BMS port on the μ Chiller controller, as shown in the figure;
2. Open Applica Desktop; a window will be opened with the right part of the top bar as shown below:

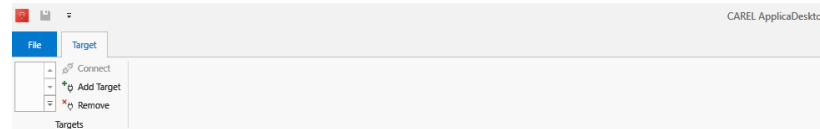

Fig.3.k

3. Select "Add target" and assign it a meaningful name (e.g. " μ Chiller");
4. In the "COM Port" field, enter the COM port used for the USB connection to the USB/RS485 converter;
5. Configure the connection parameters (Baudrate=115200, Bits=8, Parity=None, Stop Bits=Two, Serial Node=1) as shown in the figure (the data are saved automatically);

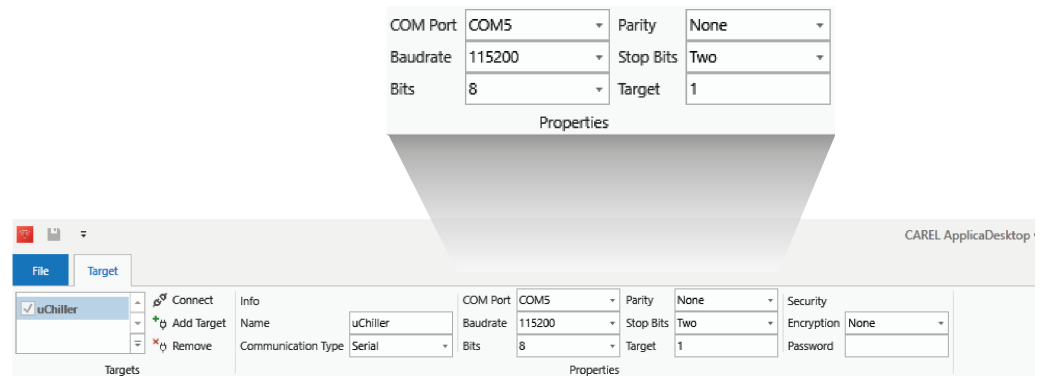

Fig.3.l

6. Use "Connect" to connect to the μ Chiller (which must be powered on);
7. Once connected, select the "Configurations" label: the command bar will be displayed, as shown:

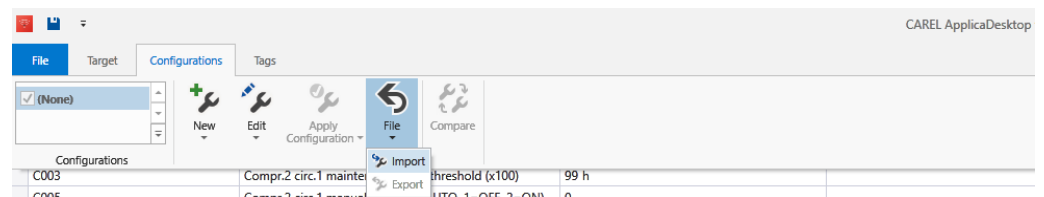
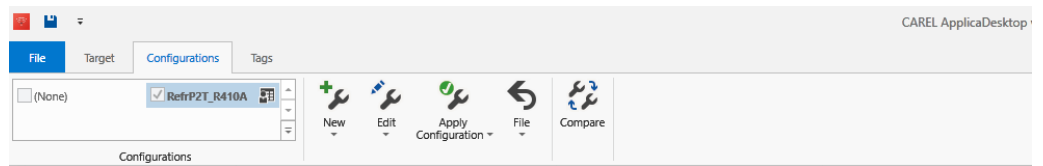

Fig.3.m

8. Select "File -> Import" to load the configurations downloaded from KSA;
9. Select the configuration to be applied to the μ Chiller, and then "Apply Configuration";

**Fig.3.n**

10. Applica Desktop will display a message when the parameters have been set, and if necessary indicating any values that have been applied that do not belong to the current user profile (some parameters may not be visible to the user).
11. Repeat the sequence of steps 8 and 9 for each configuration to be applied.

Note: Applica Desktop features complete on-line help, available by clicking the "?" on the right-hand side of the top bar in the window (see the figure):

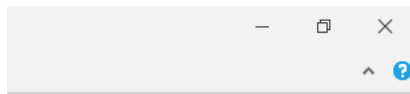
**Fig.3.o**



4. User interface

4.1 Introduction

µChiller uses the user terminal to display the alarms, the main variables and to set the unit set points (User level) and manual functions (Service level). The terminal has a 7-segment LED display with two rows: the top row is 3-digit plus sign and decimal point; the bottom row is 4-digit plus sign (this can also display the hour format -hh:mm and date - MM:DD). There is a buzzer, 14 operating icons and 4 buttons for scrolling and setting the parameters. The terminal has NFC (Near Field Communication) and Bluetooth (depending on the model) connectivity for interaction with mobile devices (on which the Carel "Applica" app has been installed, available on Google Play for the Android operating system).

Note: access levels: U=User; S=Service; M=Manufacturer. See the parameter table.

The unit of measure on the display can be changed via parameter UoM, accessed at a Service level, including in the direct access functions menu.

Code	Description	Def.	UoM	Min	Max	Lev.
UoM	Unit of measure 0=°C/barg 1=°F/psig	0	-	0	1	S

The information and parameters accessible from the terminal and from the Applica app depend on the access level and the unit configuration parameters.

4.2 User terminal

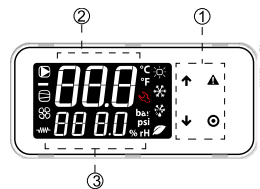

Key	
1	Keypad
2	Main field
3	Device status and operating mode icons

Fig.4.a









Note: the user terminal only allows access to certain parameters at the User and Service levels: to access all of the Service and Manufacturer parameters, use the Carel Applica app or the configuration and commissioning tool.

4.2.1 Keypad

Button	Description	Function
	UP	- When scrolling: go to the previous parameter - In programming mode: increase the value
	DOWN	- When scrolling: go to the next parameter - In programming mode: decrease in value - Main menu: - pressed briefly: unit dashboard display - pressed and held (3 s): access User parameters (set point, unit on-off, ...)
	Alarm	- Pressed briefly: display active alarms and mute buzzer - Pressed and held (3 s): reset alarms.
	PRG	- When scrolling: access parameter programming mode - In programming mode: - pressed briefly: confirm value - pressed and held (3 s): return to the main menu

4.2.2 Icons

The icons indicate the device operating status and operating modes, as shown in the following table.

Icon	Function	On	Flashing
	System pump	Active	In manual operation
	Source device status (pump/fan)	Active	In manual operation
	Compressor status	Active	In manual operation (with ExV)
	Frost protection heater	Active	-
	Operating mode	Heating	-
		Cooling	High water temperature
		Defrost	Dripping after defrosting
		Free cooling	-
	Service	Service request on exceeding operating hours	Serious alarm, action required by qualified personnel

4.3 Standard display

At start-up, the user terminal briefly shows "NFC", indicating that the NFC interface is available on the user terminal for communication with mobile devices, and then the standard display is shown. The standard display shows:

- on the top row: the delivery water temperature;
- on the bottom row, when the unit is on, the return water temperature; when the unit is off, it shows "OFF".

Note: "bLE" flashes on the display during "Bluetooth" communication.

4.3.1 Dashboard

From the main menu, press DOWN to access information on the status of the devices and the temperatures, superheat values, etc. for the two circuits:

- unit "OFF" and the reason for shutdown:
 - "diSP" from keypad;
 - "dI" from remote contact (via digital input);
 - "Schd" from time band (scheduler);
 - "bMS" from BMS;
 - "ChnG" from operating mode changeover (heating/cooling);
 - "AlrM" from alarm.
 - "CMP" compressors;
 - "EuP1" evaporation temperature circuit 1;
 - "SSH1" superheat circuit 1;
 - "Cnd1" condensing temperature circuit 1;
 - "dSt1" BLDC compressor discharge temperature circuit 1;
 - "EuP2" evaporation temperature circuit 2;
 - "SSH2" superheat circuit 2;
 - "Cnd2" condensing temperature circuit 2;
 - "dSt2" BLDC compressor discharge temperature circuit 2;
- and if the access level is "Service":
- "Hd00" supervisor address (BMS);
 - "Hd01" BMS baud rate;
 - "Hd02" BMS communication parameters;

- "ESC" to exit the dashboard.

Example



Go to the standard display.



Press DOWN: CMP indicates that compressor 1 is on (o) and compressor 2 is off (␣).



Press DOWN: EuP1 indicates the evaporation temperature in circuit 1 (3.8°C).



Press DOWN: Cnd1 indicates the condensing temperature in circuit 1 (40.8°C).



To return to the standard display, press PRG (corresponding to ESC).

4.3.2 Direct access functions

The user terminal only provides access to the basic configuration parameters, such as direct functions and active alarms without password protection, or, with password protection, to the parameters used to configure and optimise the unit.

Press DOWN for 3 s to access the direct access functions:

- set point;
- switching unit on and off;
- change operating mode (cooling/heating, only on reverse-cycle units);
- select unit of measure.

In programming mode, the bottom row shows the parameter code, and the top row shows the value.

Procedure

Press:

- DOWN for 3 s to access the parameters (User level, no password required);
- UP and DOWN to scroll and set the parameters;
- PRG to change the parameter value and save the changes;
- PRG (3 s) or ESC to return to the standard display.



1. Go to the standard display



2. Press DOWN for 3 s: the current set point (SEtA) is shown - read-only



3. Press DOWN: the cooling set point (SEtC) is shown



4. Press PRG: the value flashes; press UP/DOWN to change the value; PRG to confirm.



5. Press DOWN: the heating set point (SEtH) is shown - for heat pump units only.



6. Press DOWN: the unit ON/OFF function (UnSt) is shown.



7. Press DOWN: the function for switching from cooling (C) to heating (H) mode (ModE) is shown - for heat pump units only.



8. Press DOWN: the manual defrost function (dFr) is shown - Service level and reverse-cycle A/W units only.



9. Press DOWN: the function to delete the alarm log (CLrH) is shown - Service level only.



10. Press DOWN: the unit of measure selection (UoM) is shown



11. After having completed the settings, to exit either: a) from the categories press ESC and then PRG; or b) press PRG for 3 s

4.3.3 Programming mode

Go to the standard display and press PRG to enter programming mode.

Procedure

Press:

- PRG to access the parameters with password protection;
- UP and DOWN to scroll and set the parameters;
- PRG to change the parameter value and save the changes;
- PRG (3 s) or ESC to return to the standard display.



1. Go to the standard display



2. Press PRG: the password prompt (PSd) is shown



3. Press PRG: the first digit of the password flashes; set the value, press PRG. The second digit now flashes; enter the other digits to complete the password.



4. Press PRG: if the password is correct, the first parameter category is shown: PLt (= system)



5. Press PRG: the first parameter is shown: U002 (Pump 1 manual control)



6. Press PRG: the value flashes; press UP/DOWN to change the value; PRG to confirm.



7. Press UP/DOWN to display the other parameters.



8. Press PRG for 3 sec or alternatively, in the parameter level select ESC and press PRG to return to the parameter categories

Note: User password: 1000; Service password: 2000; Manufacturer password: 1234. See the parameter table.

4.3.4 Programming menu



Category PLt (system): identified by code Uxxx, these parameters all relate to control and management of the system units.



Category EEV (ExV valve): identified by code Exxx, these parameters all relate to control and management of the electronic expansion valve (s).



Category CMP (compressors): identified by code Cxxx, these parameters all relate to control and management of the compressors and refrigerant circuits.



Category Src (source): identified by code Sxx, these parameters all relate to control and management of the condenser / source.



Category Clc (Clock):
identified by code Haxx,
these are the parameter
for setting the date/time.

Category Hst (Alarm log):
access the alarm log. Each
event is described with the
date (in the format DD
MM) and time (in the
format hh:mm)
alternating.

Use Log-Out to exit the
category.

Use ESC to return to the
standard display.

🔍 **Note:**

- the Service password also accesses the User parameters;
- if no button is pressed, after around 3 minutes the terminal will automatically return to the standard display.

5. Functions

5.1 Temperature control

µChiller can control either the unit's return or delivery water temperature. Regardless of how the cycle is reversed (water or refrigerant circuit), probes S1 and S2 are always the return (from user) and delivery (to user) water temperature probes. See the Installation chapter.

5.1.1 PID control

Two types of PID control are available:

- PID control at start-up;
- PID control in operation.

For each type of PID control, the following parameters can be set:

- Control probe (return or delivery);
- Proportional gain (Kp);
- Integral time (action disabled when time set to 0);
- Derivative time (action disabled when time set to 0).

The control set point and the operating mode (heating / cooling) are the same for both control types:

- control at start-up is aimed at preventing excess capacity being called. Indeed, as when starting the exact status of the units (loads) is not known, but rather only the temperature, capacity needs to be delivered gradually, awaiting the reaction from the system. Control can be applied to the water return temperature, using a low gain and a sufficiently high integral time, greater than the system time constant (120-180 s, considering a system time constant of at least 60 s, corresponding to a minimum water content of 2.5 l/kW).
- control in operation needs to be more reactive, so as to respond quickly to any variations in load and keep the delivery water temperature as close as possible to the set point. In this case, the time constant depends on the response of the compressor-evaporator system, and is in the order of a few tens of seconds (slower with tube bundle evaporators, faster with plate evaporators).

The following table shows the recommended values (to be calibrated if necessary during system commissioning), according to the type of evaporator used.

Code	Description	Evaporator	
		Tube bundle	Plate
U036	Control probe at start-up 0=Return 1=Delivery	Return	Return
U039	PID at start-up: Kp	6.0	6.0
U040	PID at start-up: Ti 0: integral action disabled	180 s	180 s
U041	PID at start-up: Td 0: derivative action disabled	0 s	0 s
U038	Control probe in operation 0=Return 1=Delivery	Delivery	Delivery
U042	PID in operation: Kp	10.0	10.0
U043	PID in operation: Ti 0: integral action disabled	120 s	120 s
U044	PID in operation: Td 0: derivative action disabled	3 s	3 s

Tab.5a

The control sequence is as follows:

1. when the unit is Off, both PID controls are disabled;
2. when the unit starts, following the set user pump – compressor delay, the PID at start-up is enabled and generates a capacity request (percentage) that is then processed so as to activate the compressors;
3. if this request is sufficient, one compressor will be started;

4. once the compressor has started, after a set time, control switches from PID at start-up to PID in operation;
 5. when the controller requests deactivation of the compressors, these are enabled to stop;
 6. after the last compressor has been stopped, restart is managed using the PID at start-up.
- If the delay between PID at start-up/in operation is set to 0, PID control in operation will always be active.

User	Code	Description	Def	Min	Max	UOM
S	U047	Compressor activation delay after user pump	30	0	999	s
S	U037	PID control delay at start-up/operation	180	0	999	s

5.1.2 Set point compensation

μChiller adjusts the set point based on the outside temperature.

Note: this function can only be enabled if the outside temperature probe is fitted..

User	Code	Description	Def	Min	Max	UOM
M	Hc00	S3 configuration 0=Not used 1=Source /external temp. 2=Discharge temp. 3=Suction temp.	0	0	1	-
M	Hc03	S6 configuration 0=Not used 1=Remote set point 2=Source /external temp. 3=Reserved	0	0	3	-

The compensation (positive or negative) is determined by:

1. start compensation start (in cooling/heating);
2. end compensation threshold (in cooling/heating);
3. maximum compensation value (in cooling/heating).

User	Code	Description	Def	Min	Max	UOM
S	U010	Enable set point compensation 0/1=no/yes	0	0	1	-
U	SEtC	Cooling set point	7.0	U006	U007	°C/°F
S	U011	Cooling compensation: start	25.0	-99.9	999.9	°C
S	U012	Cooling compensation: end	35.0	-99.9	999.9	°C
S	U013	Cooling compensation: maximum value	5.0	-99.9	999.9	K
U	SEtH	Heating set point	40.0	U008	U009	°C/°F
S	U014	Heating compensation: start	5.0	-99.9	999.9	°C
S	U015	Heating compensation: end	-10	-99.9	999.9	°C
S	U016	Heating compensation: maximum value	5.0	-99.9	999.9	K

Compensation in cooling:

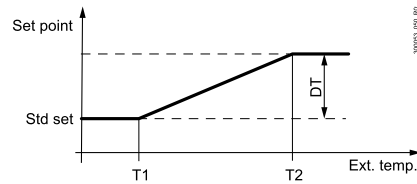

Fig.5.a

Key

Ext. Temp.	Outside temperature
Std set	Control set point
T1	Outside temperature to start compensation in cooling mode
T2	Outside temperature to end compensation in cooling mode
DT	Maximum compensation value in cooling mode

Compensation in heating:

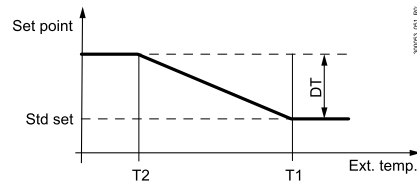

Fig.5.b

Key

Ext. Temp.	Outside temperature
Std set	Control set point
T1	Outside temperature to start compensation in heating mode
T2	Outside temperature to end compensation in heating mode
DT	Maximum compensation value in heating mode

5.1.3 Request from BMS

The request can be managed directly from a BMS, bypassing normal temperature control and enabling the external request signal (0-100.0%) via the specific Modbus serial variable (BMS_PwrReq, HR 331). This operation is enabled via another serial variable (En_BMS_PwrReq, CS 22).

Note: if the supervisor is offline, the unit continues to operated in stand-alone mode, regardless of the request from the BMS.

5.1.4 High evaporator outlet temperature alarm

µChiller activates an alarm when the evaporator outlet temperature exceeds the threshold set by the user (via the offset relative to the control set point). When the outlet temperature exceeds the threshold, a counter starts and after a delay (settable), the alarm is activated. An initial delay disables the alarm in the transient period when the unit is starting.

Note:

- the alarm is only available on chiller units.
- the high temperature alarm can be used to activate a backup unit in critical applications.

User	Code	Description	Def	Min	Max	UOM
U	SetA	Current set point	-	-999.9	999.9	°C
S	U031	High water temperature alarm: offset	10.0	0.0	99.9	K
S	U032	High water temperature alarm: delay at start-up	15	0	99	min
S	U033	High water temperature alarm: delay in operation	180	0	999	s

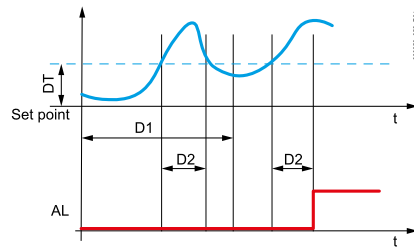
Fig.5.c
Key

Set point	Current set point
DT	Offset
D1	Delay at start-up
D2	Delay in steady operation
AL	Alarm

5.2 User pumps

μChiller can manage up to two user-side pumps (depending on the hardware used and the required configuration).

A delay can be set between pump and compressor activation (= temperature control enabled). A delay can also be set between the deactivation of the last compressor and the pump. If when the unit shuts down the compressors have been shutdown for at least the “user pump shutdown delay after compressor”, then the pump is stopped immediately.

User	Code	Description	Def	Min	Max	UOM
S	U047	Compressor activation delay after user pump	30	0	999	s
S	U048	User pump shutdown delay after compressor	180	0	999	s

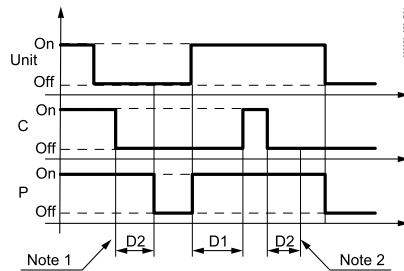
Fig.5.d
Key

Unit	Unit On-Off (local or remote control)
C	Compressor
P	User pump
D1	Compressor activation delay after user pump
D2	User pump shutdown delay after compressor
Note 1	Control is not active: the compressors are stopped based on their own safety times
Note 2	In this case, the pump can stop immediately

Below is a diagram that represents operation for the configuration with one pump only:

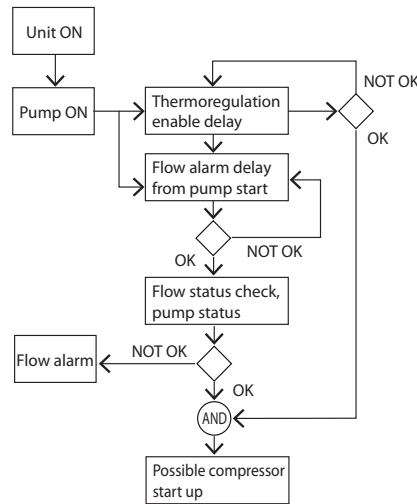

Fig.5.e

Temperature control is enabled only after the flow alarm delay from pump on, so as to prevent the compressors from starting if there is no fluid flow.

Depending on the configuration, up to two user pumps can be enabled. µChiller includes the following features:

- with two pumps, automatic rotation to ensure fluid circulation and equalisation of operating hours. Rotation is performed:
 - at the end of a period that can be set, in hours;
 - when there is an overload alarm on the active pump.
- management of the pump overload alarm (if available, depending on the controller and configuration). Fault signal and immediate pump deactivation.
- Management of a flow switch that monitors fluid circulation in the system.
- frost protection with unit off: the pump is started so as to activate fluid circulation (when the unit is on, the function is disabled).
- pump anti-blocking: if the pump is off for more than a week, it is activated for 3 seconds.

User	Code	Description	Def	Min	Max	UOM
S	U049	User pump rotation time	12	0	999	h

5.3 Frost protection control

Frost protection control is managed using the evaporation pressure probe, which directly monitors the conditions of the evaporator. The water delivery temperature probe is ignored, as this does not provide a significant indication of the possibility of ice forming inside the evaporator.

5.3.1 Frost protection alarm

When there is a frost alarm on the evaporator, the corresponding circuit is shut down. Each circuit manages its own evaporation pressure probe, and consequently also the frost protection alarm. The evaporation temperature value is filtered based on an exponential distribution formula that takes into consideration the thermal mass of the evaporator so as to avoid false alarms at start-up. A specific algorithm uses this filtered value and activates the alarm if the frost protection threshold is exceeded.

User	Code	Description	Def	Min	Max	UOM
S	U050	User side frost protection: alarm threshold	-0.8	-99.9	999.9	°C
S	U051	User side frost protection: differential	30.0	0.0	999.9	K
S	U052	User-side frost protection: delay time at 1K	30	0	999	s

The figure shows the action of the filter on the evaporation temperature, according to the exponential distribution formula.

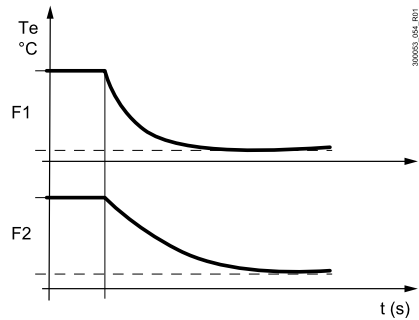

Fig.5.f

Key

Te	Filtered evaporation temperature
F1	Filter with low delay
F2	Filter with high delay

When the filtered evaporation temperature falls below the alarm threshold, a counter is activated, and the counter time-out is either increased or decreased based on the deviation of the evaporation temperature from the frost protection threshold, until reaching zero when the deviation from the threshold it is greater than the differential, following a hyperbolic trend. This trend imitates the actual behaviour of ice formation and ensures better protection. The following diagram shows the trend in the alarm delay time according to the deviation from the alarm threshold, using the following values: delay time at 1K=60s; differential=30K. At the threshold the delay is equal to 10 times the set value (600s in the example).

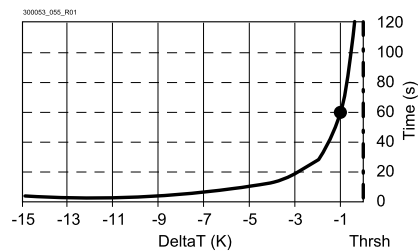

Fig.5.g

Key

Time [s]	Frost protection alarm delay
Thrsh	Frost protection alarm threshold
DeltaT [K]	Deviation from the frost protection alarm threshold

Frost protection alarm operation:

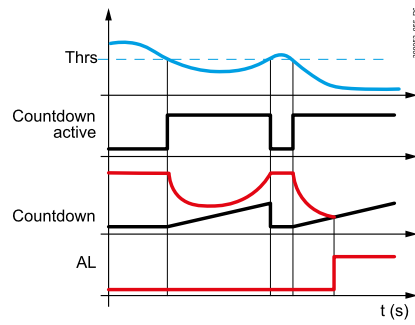

Fig.5.h

Key

t [s]	Time [s]
Thrs	Frost protection alarm threshold
AL	Frost protection alarm

The value of the delay (at 1K) in the previous example refers to a plate evaporator; if a tube bundle evaporator is used, which has greater thermal inertia, the delay time (at 1K) can be increased to a suitable value. The following table shows the recommended values for the alarm threshold (with pure water), differential and delay, according to the type of evaporator used.

Code	Description	Recommended values based on the heat exchanger	
		Tube bundle	Plate
U050	User side frost protection: alarm threshold	-0.3 °C	-1.2 °C
U051	User side frost protection: differential	30 °C	30 °C
U052	User-side frost protection: delay time at 1K	90 s	60 s

Tab.5.b

With pure water, the frost protection threshold must be set just below zero (from -0.8°C to -1.5°C) to account for the heat transfer temperature gradient across the metal between the refrigerant and the water. For tube bundle heat exchangers, values close to zero (above -0.5°C) should be considered, to guarantee better protection due to their specific mechanical construction.

5.3.2 Frost protection threshold with glide (R407C)

A correct frost protection threshold also needs to consider the minimum temperature reached inside the evaporator. When using refrigerants without glide or with minimum glide (e.g. R410A, R134a), the value coincides with the pressure-temperature conversion (dew) of the transducer fitted on the suction pipe, while for refrigerants with glide (e.g. R407C), the value to be used is lower than the pressure-temperature conversion (in the case of R407C it is 5-6°C). The following diagram clearly shows the difference between the two temperature values (T_{in} and T_{out}) at the evaporation pressure (P_{evap}) due to the "glide" effect of the refrigerant.

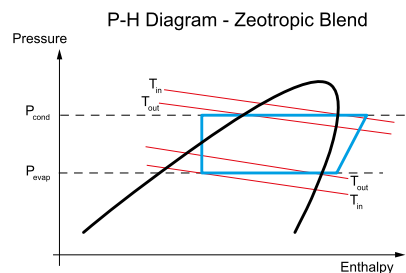

Fig.5.i

Key	
Tin (Pevap)	Evaporator refrigerant inlet temperature
Tout (Pevap)	Saturated evaporation temperature "dew"
Pcond	Condensing pressure
Pevap	Evaporation pressure

Note: as a consequence of the above, the suggested frost protection set point with pure water and R407C refrigerant is 4-4.5°C.

5.3.3 Frost prevention

The frost protection threshold on the evaporation temperature is used as the minimum evaporation temperature threshold for frost prevention. Prevention is applied by limiting circuit capacity when the threshold is exceeded.

5.3.4 Frost protection with the unit OFF

When the unit switched off, µChiller provides frost protection: the water is prevented from freezing by activating a pump and/or frost protection heater. When the water temperature in the heat exchangers reaches the frost protection set point, the selected device is activated.

The probe used is the one located on the user heat exchanger outlet and source heat exchanger inlet.

The following devices can be activated:

- heater;
- pump;
- heater and pump.

User	Code	Description	Def	Min	Max	UOM
S	U053	Unit OFF: frost protection set point	4.0	-99.9	999.9	°C
S	U054	Unit OFF: frost protection differential	2.0	0.0	99.9	K
S	U075	Frost protection type 0=Heater 1=Pump 2=Heater/Pump	2	0	2	-

5.4 Compressor rotation

If there is just one compressor, the temperature control request will be exactly the same as the request that the compressor needs to satisfy. On units with two compressors, µChiller manages rotation in order to balance compressor operating hours and starts, so as to best deliver the required capacity.

5.4.1 Type of rotation

µChiller starts and stops the compressors based on:

- FIFO rotation (First In First Out), meaning the first compressor to start will also be the first to stop;
- activation time: the first compressor to start will be the one with the lowest number of operating hours.

If the circuit is equipped with a variable-speed (BLDC) compressor, this will always be the first to start and the last to stop.

User	Code	Description	Def	Min	Max	UOM
M	C048	Compressor rotation type 1=FIFO 2=Time	1	1	2	-

5.4.2 Capacity distribution

µChiller manages the most suitable capacity distribution between the circuits so as to increase overall unit efficiency. The behaviour of capacity distribution varies based on:

- whether there are 1 or 2 circuits;
- the type of compressor(s) used: modulating (BLDC) or fixed speed;
- the ratio between compressor capacities.

To avoid simultaneous starts or stops of several compressors, there are two fixed minimum delays: one between starts (30 s) and the other (10 s) between stops.

Compressor capacity distribution in steps

Below is an example of capacity distribution with two circuits in the tandem configuration with two fixed-speed compressors (scroll), each with the same capacity, and FIFO rotation.

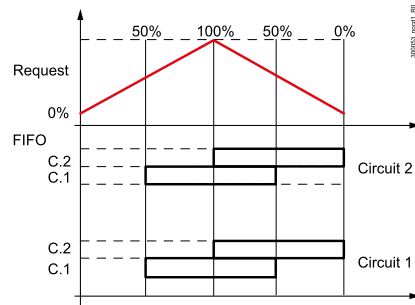

Fig.5.j

Key	
Request	Capacity request (temperature control)
C.1	Compressor 1
C.2	Compressor 2

Capacity distribution with BLDC compressors

If the circuit is equipped with a BLDC compressor, this will always be the first to start and the last to stop. Circuit operation is modulated so as to meet the capacity request, adjusting BLDC compressor speed and controlling the activation of ON-OFF compressors.

5.4.3 Rotation due to alarm

In the event of a compressor alarm, the next compressor available will be switched on as a replacement if the temperature control request is sufficiently high as to warrant starting another compressor.

5.4.4 Force rotation (destabilisation)

Some compressor manufacturers specify that on units with multiple compressors, the compressors need to be rotated after a certain period of inactivity, even if control is stable.

The destabilisation function, which meets this requirement:

- can be enabled by parameter;
- avoids refrigerant migration during long periods of inactivity;
- can also be used to keep all the compressors at operating temperature.

User	Code	Description	Def	Min	Max	UOM
M	C020	Maximum circuit destabilisation time	240	5	999	min
M	C044	Enable destabilisation 0/1=No/Yes	1	0	1	-

5.5 Compressor management

µChiller manages scroll compressors with direct starting or modulating BLDC compressors (scroll and rotary). A maximum of 4 scroll compressors is available in tandem configuration on two circuits; in the HE configuration (high efficiency with BLDC): maximum 1 BLDC + 1 On-Off in just one circuit. The flow chart below shows the process for calculating the request to the compressors:

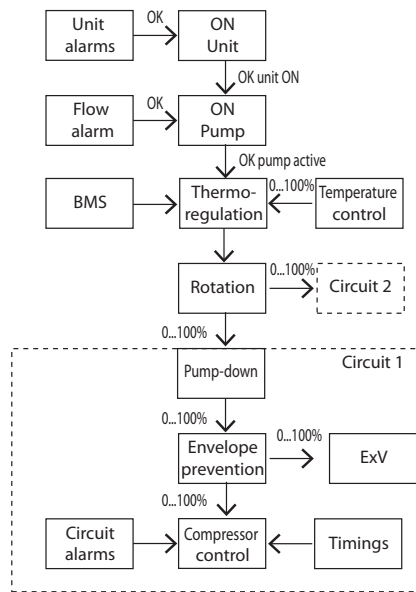

Fig.5.k

Note: for the sake of simplicity, the parameters are shown for just one compressor and one circuit, therefore all the compressors and circuits on the unit will have the same settings.

5.5.1 Predefined BLDC compressors

The type of BLDC compressor can be chosen from the list of compressors available on KSA (ksa.carel.com), μ Chiller section.

When selecting a specific type of compressor, the following parameters are set based on the compressor manufacturer's technical specifications:

1. compressor motor:
 - all the characteristic electrical parameters of the compressor motor;
 - minimum and maximum frequency settings, acceleration and deceleration ramps.
2. compressor envelope:
 - all the characteristic points that define the shape of the compressor envelope;
 - maximum discharge temperature (compressor outlet).
3. compressor envelope management:
 - MOP and pressure difference (DeltaP), minimum ExV opening parameters;
 - working point control parameters;
 - prevention parameters.

5.5.2 Safety times

μ Chiller guarantees compliance with compressor safety times, such as:

- minimum on time;
- minimum off time after deactivation request from controller;
- minimum time between consecutive starts.

User	Code	Description	Def	Min	Max	UOM
M	C012	Min compressor on time	180	30	999	s
M	C013	Min compressor off time	60	30	999	s
M	C014	Min time between consecutive compressor starts	360	300	999	s

5.5.3 BLDC compressor start-up

µChiller manages the start-up of BLDC compressors in accordance with the manufacturer's specifications: on starting, the compressor is brought to start-up speed and kept at that speed, irrespective of the control request, for the entire minimum on time.

At the end of this period, the speed is modulated by the controller, based on:

- request;
 - position of the working point in relation to the compressor envelope (see par. "Prevention actions").
- ➔ **Note:** if at start-up the differential pressure is greater than the maximum allowed start-up threshold, the compressor remains on call awaiting the pressure to drop below the threshold. If after 5 minutes the compressor has not yet started, a specific alarm will be activated (A43/A76). However, this alarm still allows the other compressors to start.

User	Code	Description	Def	Min	Max	UOM
M	P021	Max. deltaP at start-up	900.0	0.0	2000.0	kPa

5.5.4 BLDC oil recovery

When the refrigerant gas speed in the circuit is below the value required to entrain the oil, operation periodically needs to be set to a sufficient value to guarantee oil return to the compressor crankcase. The function forces an increase in BLDC compressor capacity for a specific time, when the circuit has remained at low load (par. P007) for a minimum time (par. P008).

User	Code	Description	Def	Min	Max	UOM
M	P018	Enable oil recovery 0/1=No/Yes	0	0	1	-
M	P007	Oil recovery: min speed for activation	35.0	0.0	999.9	rps
M	P008	Oil recovery: comp. operating time at low speed	15	0	999	min
M	P009	Oil recovery: force comp. speed time	3	0	999	min
M	P010	Oil recovery: force comp. speed value	50.0	0.0	999.9	rps

5.5.5 Tandem BLDC oil equalisation

A solenoid valve is activated to take the oil from the crankcase overflow on each compressor and put it back in circulation (for example, at the inlet to the common manifold). If the function is enabled, when the fixed speed compressor starts, the solenoid valve is activated for an initial time (par. P011), and then cyclically for a time (par. P012), with a pause that increases over time from the minimum value (par. P013) to the maximum value (par. P014) in the specified time (par. P015).

User	Code	Description	Def	Min	Max	UOM
M	P017	Enable oil equalisation valve 0/1=No/Yes	0	0	1	-
M	P011	Oil equalisation: solenoid valve opening time at start-up	30	0	999	s
M	P012	Oil equalisation: solenoid valve opening time	3	0	999	s
M	P013	Oil equalisation: min solenoid valve closed time	1	0	999	min
M	P014	Oil equalisation: max solenoid valve closed time	15	0	999	min
M	P015	Oil equalisation: solenoid valve closed time increment	20	0	999	min

5.6 BLDC compressor protectors

To prevent the compressor from working outside the safety limits specified by the manufacturer, µChiller provides controls the operating limits (defined as the envelope) of BLDC compressors. In addition to the operating limits specified by the manufacturer, the maximum condensing temperature (par. P001) and minimum evaporation thresholds (par. P000) can be customised; these custom thresholds are considered only if they are more restrictive than the manufacturer's limits. On-Off compressors have no envelope data: the operating limits can be set using the parameters for the maximum high pressure threshold -

equivalent temperature (par. C017), frost protection alarm thresholds (par. U050 and S057) and MOP threshold (to control the maximum evaporation temperature, par. E020 and E022).

User	Code	Description	Def	Min	Max	UOM
S	P000	Min evaporation temp.: custom limit	-25.0	-99.9	999.9	°C/°F
S	P001	Max condensing temp.: custom limit	70.0	-99.9	999.9	°C/°F
M	C017	Max high pressure threshold (HP)	65.0	0.0	999.9	°C
M	C018	Min low pressure threshold (LP)	0.2	-99.9	99.9	bar
S	U050	User side frost protection: alarm threshold	-0.8	-99.9	999.9	°C
S	S057	Source frost protection: alarm threshold	-0.8	-999.9	999.9	K
M	E020	MOP in cooling: threshold	30.0	-60.0	200.0	°C
M	E022	MOP in heating: threshold	20.0	-60.0	200.0	°C

Below is the description of the working zones in a generic envelope for a BLDC compressor:

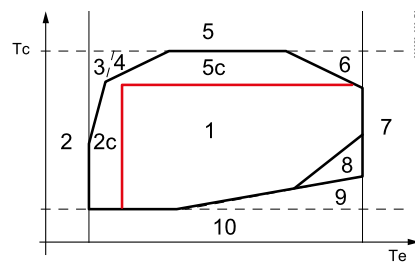

Fig.5.1

Zone	Par.	Description
1		Zone inside the operating limits (the prevention function is still active to prevent operation outside of the limits)
2		Minimum evaporation pressure
2 c	P000	Custom minimum evaporation pressure threshold
3		Maximum compression ratio 1
4		Maximum compression ratio 2
5		Maximum condensing pressure
5 c	P001	Custom maximum condensing pressure threshold
6		Maximum motor current
7		Maximum evaporation pressure
8		Minimum compression ratio
9		Minimum differential pressure
10		Minimum condensing pressure
11		High discharge temperature (but working pressure inside the envelope)

When the compressor working point is outside of the envelope, an alarm delay starts counting: if the working point remains outside of the envelope, when the delay expires, a specific alarm is activated that stops the compressor; if, on the other hand, the working point returns back inside the envelope limits, the alarm delay is reset.

The high condensing pressure limit is determined by the minimum between:

- the nominal compressor threshold;
- the threshold modifiable by Service (par. P001).

The high evaporation pressure limit is determined by the minimum between:

- the nominal compressor threshold;
- the set MOP threshold (par. E020: chiller and E022: heat pump);

The low evaporation pressure limit for the prevention action is determined by maximum between:

- the nominal compressor threshold;
- the threshold modifiable by Service (par. P000);
- the frost protection limit, depending on the mode (par. U050 in cooling and par. S057 in heating with water/water units).

In addition to the operating limits defined by the shape of the envelope, there is also (heat pump versions only) a "Maximum discharge temperature" limit (specified by the compressor manufacturer), at which the compressor is shut down.

5.7 BLDC comp. alarm prevention

The suction and discharge pressure determine a working point in a zone of the envelope, and depending on the zone, the controller applies corrective actions to maintain or return BLDC compressor operation within the limits.

5.7.1 Prevention actions for BLDC compressors

Below is the description of the working zones in a generic envelope for BLDC compressors:

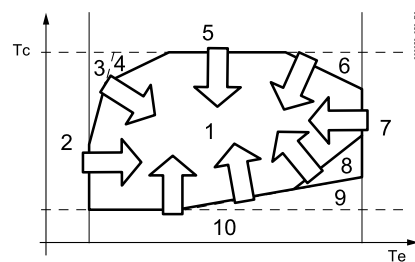

Fig.5.m

Zone	Description
1	Zone inside the operating limits
2	Prevention due to low evaporation pressure
3-4	Prevention due to high compression ratio
5	Prevention due to high condensing pressure
6	Prevention due to high motor current
7	Prevention due to high evaporation pressure
8	Prevention due to low compression ratio
9	Prevention due to low differential pressure
10	Prevention due to low condensing pressure

Tab.5.c

To allow the compressor to work inside the envelope, specific prevention actions are adopted that adjust circuit capacity, the source fan set point and the opening of the ExV valve.

In particular, the actions involving circuit capacity are:

- decrease the rate at which the capacity request from the temperature controller increases/decreases when approaching the limit of the envelope;
- limit/increase circuit capacity.

The action on the ExV valve is applied by varying the MOP threshold (maximum evaporation temperature): the algorithm follows the set point, decreasing valve opening, and therefore reducing the mass flow of refrigerant, which in turn lowers the evaporation temperature. This action is applied with both BLDC compressors and fixed-speed compressors.

The actions involving the rate of capacity variation start when the working point is a set distance from the compressor operating limits. These actions are only possible with BLDC compressors.

In the event of fixed-speed compressors, the only actions possible on the circuit are to limit capacity via the number of the compressors on: this is implemented as soon as the working point exceeds the maximum condensing temperature (par. C017) or minimum evaporation temperature (par. U050/S057) or minimum evaporation threshold (par. C018) - or the minimum of the two.



Below are details of the various actions to prevent the operating limits from being exceeded; action 1 refers to the control action (before exiting the envelope); action 2 to the limiting action (working point already outside of the envelope).

Low evaporation pressure prevention (zone 2)

The low evaporation pressure limit for the prevention action is determined by maximum between:

- the nominal compressor threshold (BLDC only);
- the threshold set by the "Manufacturer": par. C018/P000 for On-Off/BLDC compressor;
- the frost protection limit, depending on the operating mode: par. U050 in cooling mode and S057 in heating mode with water/water units.

Device	Description
BLDC compressor	1. Decrease the rate of capacity increase. 2. Limit capacity
Tandem on-off compressors	1. - 2. Shutdown a compressor
ExV	-
Fan	-

High compression ratio prevention (zones 3-4)

A high compression ratio is a thermal limit of compressor operation: normally control is activated at the limit of the envelope, reducing capacity when the limit is exceeded; if a probe is fitted to measure discharge temperature (HP version only) and if the temperature approaches the limits, compressor capacity will be modulated so as to managed the critical condition. A specific algorithm initially slows down the increase in capacity, until stopping it completely when at the set point (5°C below the maximum limit); if the temperature increases further, the algorithm gradually and slowly reduces capacity, taking into account compressor thermal inertia.

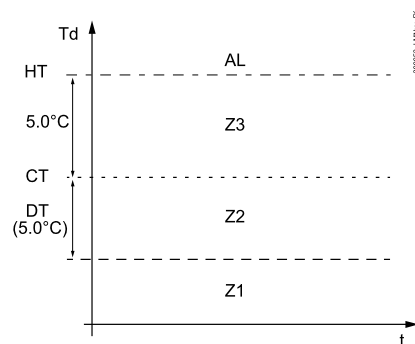

Key

Td	Discharge temperature
HT	Low discharge temperature alarm threshold
CT	High discharge temperature control threshold
DT	Control action deviation
AL	High discharge temperature alarm zone
Z3	Capacity reduction zone
Z2	Acceleration control zone
Z1	Normal operating zone

Device	Description
BLDC compressor	1. Decrease the rate of capacity increase. 2. Limit capacity
Tandem on-off compressors	-
ExV valve	-
Fan	-

High condensing pressure prevention (zone 5)

Device	Description
BLDC compressor	1. Decrease the rate of capacity increase. 2. Limit capacity
Tandem on-off compressors	1. - 2. Shutdown a compressor
ExV valve	-
Fan	-

High motor current prevention (zone 6)

Device	Description
BLDC compressor	1. Decrease the rate of capacity increase. 2. Limit capacity
On-off compressors tandem	1. - 2. Shutdown a compressor
ExV valve	MOP with specific algorithm
Fan	-

High evaporation pressure prevention (zone 7)

Device	Description
BLDC compressor	1. Decrease the rate of capacity reduction. 2. -
Tandem on-off compressors	-
ExV valve	MOP
Fan	-

Low compression ratio prevention (zone 8)

Device	Description
BLDC compressor	1. Decrease the rate of capacity reduction. 2. Increase capacity
Tandem on-off compressors	-
ExV valve	Variable MOP
Fan	Increase condensing pressure set point/decrease evaporation pressure set point

Low differential pressure prevention (zone 9)

Device	Description
BLDC compressor	1. Decrease the rate of capacity reduction. 2. Increase capacity
Tandem on-off compressors	-
ExV valve	Variable MOP
Fan	Increase condensing pressure set point/decrease evaporation pressure set point

Low condensing pressure prevention (zone 10)

Device	Description
BLDC compressor	1. Decrease the rate of capacity reduction. 2. Increase capacity
Tandem on-off compressors	-
ExV valve	-
Fan	-



5.8 Compressor alarms

Compressor shutdown

If abnormal conditions occur and the prevention actions are not effective, the compressor will be shut down so as to avoid damage to the compressor itself or other unit components, i.e. the control algorithm stops the compressors and closes the expansion valve.

The compressors will be available again after the:

- minimum compressor off time (par. C013);
- minimum time between consecutive compressor starts (par. C014).

User	Code	Description	Def	Min	Max	UOM
M	C013	Min compressor off time	60	30	999	s
M	C014	Min time between consecutive compressor starts	360	300	999	s

Compressor delay at start-up/in operation

Compressor start-up is a critical phase. μ Chiller thus manages certain alarms differently, in order to switch smoothly from start-up to normal, steady operation. These alarms are:

- low differential pressure;
- out of envelope alarm.

There are thus two delays for these alarms:

- delay at start-up;
- delay in operation.

The alarm condition is ignored when the compressor is off and during the start-up phase. When the unit reaches steady operation, the condition causes the corresponding alarm once the delay has elapsed.

Behaviour will thus be as follows:

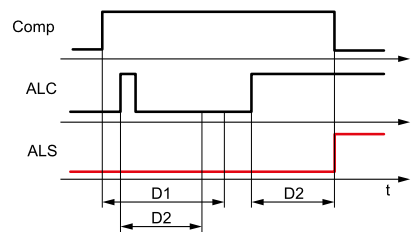

Fig.5.n

Key	
Comp	Compressor status
ALC	Status of the alarm condition
ALS	Alarm signal
D1	Alarm disabling from compressor start-up
D2	Alarm delay in operation
t	Time

5.9 Power+ Speed drive

When the unit is fitted with a BLDC compressor, this is controlled by the Power+ speed drive, connected to the FBus serial port on μ Chiller via the Modbus master protocol with a baud rate of 19200 bps. Use a specific cable for RS485 (AWG20-22 with 1½ twisted pair plus shield). See the Power+ instruction manual +0300048EN.

5.10 Expansion valve driver

The driver to manage the electronic expansion valve is a fundamental device for the μ Chiller controller. This is used to safely manage the compressor and thus the circuit, constantly controlling the discharge temperature and the position of the working point inside the compressor envelope. The solution provided manages unipolar valves up to a certain cooling capacity (Carel E3V - cooling capacity up to 90-100 kW) with the built-in driver (DIN model only) and bipolar valves with higher capacities, using the external EVD Evolution driver. This must be connected to the FBus serial port on μ Chiller via the Modbus master protocol with a baud rate of 19200 bps. Use a specific cable for RS485 (AWG20-22 with 1½ twisted pair plus shield). See the chapter "Installation".

Note: EVD Evolution is only used as an expansion valve positioner.

5.11 Control of the expansion valve

The control logic manages various functions:

- communication with the EVD Evolution driver, if used (read/write parameters via FBus serial port);
- control of suction superheat (SSH);
- low superheat control and alarm (Low SH);
- minimum evaporation temperature control and alarm (LOP);
- maximum evaporation temperature control and alarm (MOP);
- control of cooling capacity, so as to position the valve correctly in the transient stages according to circuit control status;
- control algorithm that calculates the valve opening steps;
- valve opening value sent to the valve driver.

If the EVD Evolution driver is offline, all the compressors are stopped immediately.

Dedicated electronic expansion valve parameters

Certain parameters relating to the electronic expansion valve vary according to the operating mode:

- chiller;
- heat pump.

These are:

- superheat parameters (set point and PID);
- alarm thresholds and integral actions for protection functions: LOP, MOP and Low SH.

5.12 Source pump

µChiller manages one source-side pump (water/water units only). In the same way as for the user pumps, the source pump is activated when the unit is switched on, and a shutdown delay after the last compressor stops can be set.

µChiller manages:

- frost protection with the unit off: the pump is started so as to activate fluid circulation (when the unit is on the function is disabled).
- pump anti-blocking: if the pump is off for more than a week, it is activated for 3 seconds.

User	Code	Description	Def	Min	Max	UOM
S	S027	Pump shutdown delay after compressor off	10	0	999	s

5.13 Source fans

On units with two circuits, µChiller manages the source (condenser) either separately (independent air circuits) or with one common air circuit, by setting a parameter: when there is a common air circuit, fan 1 works based on the higher request between circuit 1 and 2.

User	Code	Description	Def	Min	Max	UOM
S	S064	Type of source air circuit 0 = Independent 1 = Common	0	0	1	-

Below is a table summarising the probes used for controlling the fans in each configuration:

Circuit	Probes used for control	
	Chiller	Heat pump
1	Condensing press./temp. circuit 1	Evaporation press./temp. circuit 1
2	Condensing press./temp. circuit 2	Evaporation press./temp. circuit 2

The control mode changes based on the operating mode (chiller or heat pump).

5.13.1 Modulating/On-Off fans

On the µChiller panel version, analogue output Y1 is the only output available: consequently to control an on-off fan, a CONVONOFF module (Carel) is needed to convert the 0-10 V analogue output into a relay control. On the versions for DIN rail mounting, relay NO6 is available and can be configured as a fan output. On-Off fans then need to be configured.



User	Code	Description	Def	Min	Max	UOM
M	Hc12	NO6 configuration 0=Frost protection 1=Source fan/pump	0	0	1	-
S	S065	Type of source fan 0/1=Modulating/ON-OFF	0	0	1	-
S	S028	Source fan in cooling: set point	30.0	-999.9	999.9	°C
S	S029	Source fan in heating: set point	10.0	0.0	99.9	°C
S	S031	Source fan in cooling: set point at start-up	45.0	0.0	999.9	°C
S	S032	Source fan: delay at start-up in cooling	240	0	999	s
S	S034	Source fan: differential in cooling	15.0	0.0	99.9	K
S	S035	Source fan: differential in heating	5.0	0.0	99.9	K
S	S036	Modulating source fan: min speed value	20.0	0.0	100.0	%
S	S037	Modulating source fan: max speed value	80.0	0.0	100.0	%

The following diagram shows the two control modes (modulating or on-off) in chiller operation (cooling):

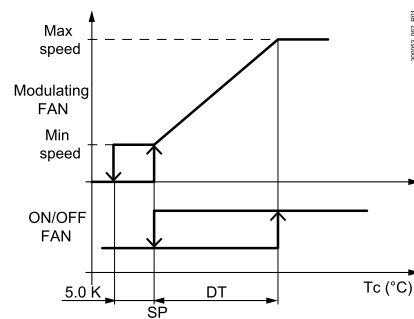

Fig.5.o

Key

Max speed	Modulating source fan: max speed value
Min speed	Modulating source fan: min speed value
SP	Control set point
DT	Control differential
Tc	Condensing temperature

5.13.2 Control in chiller mode

Fan control may be modulating or ON-OFF and is based on the saturated temperature value, equivalent to the condensing pressure, limited by Tc max.

User	Code	Description	Def	Min	Max	UOM
S	C017	Max high pressure threshold (HP)	65.0	0.0	999.9	°C
S	S028	Source fan in cooling: set point	30.0	-999.9	999.9	°C
S	S034	Source fan: differential in cooling	15.0	0.0	99.9	K
S	S036	Modulating source fan: min speed value	20.0	0.0	100.0	%
S	S037	Modulating source fan: max speed value	80.0	0.0	100.0	%

The control diagram is shown below:

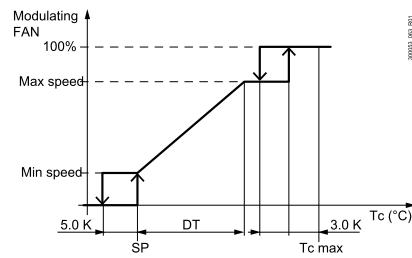

Fig.5.p

Key

Max speed	Modulating source fan: max speed value
Min speed	Modulating source fan: min speed value
SP	Control set point
DT	Control differential
Tc max	Maximum condensing temperature
Tc	Condensing temperature

In the graph, some offsets are expressed with a numerical value, indicating that they are not modifiable but rather are fixed parameters. The current calculated set point value is displayed on the dashboard.

Set point control

In chiller mode, a specific condensing temperature set point for starting the compressor can be set to a value that is higher than the nominal set point, so that the compressor can reach steady operation more quickly. The transition to the nominal set point is made gradually over a time equal to the delay at start-up.

User	Code	Description	Def	Min	Max	UOM
S	S031	Source fan in cooling: set point at start-up	45.0	0.0	999.9	°C
S	S032	Source fan: delay at start-up in cooling	240	0	999	s

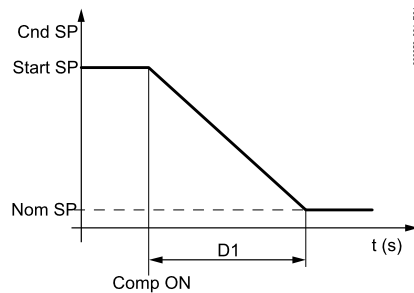

Fig.5.q

Key

Cnd SP	Condensing temperature set point
Start SP	Set point at start-up
Nom SP	Nominal set point
Cmp ON	Compressor activation
D1	Delay at start-up

5.13.3 Control in heat pump mode

Fan control may be modulating or ON-OFF and is based on the saturated temperature value, equivalent to the evaporation pressure.

User	Code	Description	Def	Min	Max	UOM
S	C017	Max high pressure threshold (HP)	65.0	0.0	999.9	°C
S	S029	Source fan in heating: set point	10.0	0.0	99.9	°C
S	S035	Source fan: differential in heating	5.0	0.0	99.9	K
S	S036	Modulating source fan: min speed value	20.0	0.0	100.0	%
S	S037	Modulating source fan: max speed value	80.0	0.0	100.0	%

The control diagram is shown below:

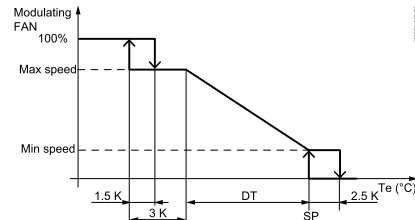

Fig.5.r

Key

Max speed	Modulating source fan: max speed value
Min speed	Modulating source fan: min speed value
SP	Control set point
DT	Control differential
Tc max	Maximum condensing temp.
Te	Evaporation temperature

In the graph, some offsets are expressed with a numerical value, indicating that they are not modifiable on the display but rather are fixed parameters. The current calculated set point value is displayed on the dashboard.

5.13.4 "Low noise" function

This function reduces the noise emitted by modulating fans by increasing the set point at night.

User	Code	Description	Def	Min	Max	UOM
S	S020	Enable noise reduction 0/1=No/Yes	0	0	1	-
S	S021	Noise reduction time band: start hours	22	0	23	h
S	S022	Noise reduction time band: start minutes	30	0	59	min
S	S023	Noise reduction time band: end hours	8	0	23	h
S	S024	Noise reduction time band: end minutes	30	0	59	min
S	S025	Source fan: noise reduction set point	45.0	0.0	999.9	°C

5.13.5 Fan anti-blocking function

For systems intended to operate in cold climates, μ Chiller modulates fan speed so as to prevent the unit from shutting down due to frost formation. The function is activated when the outdoor temperature falls below a threshold, and, instead of turning off the fans, keeps them on at a minimum speed. If the outside temperature is reached when the fans are off, these are activated at start-up speed for a certain time, and then switch to the minimum speed.

User	Code	Description	Def	Min	Max	UOM
S	S016	Source fan: cold climate temperature threshold	-0.5	-999.9	999.9	°C
S	S017	Source fan: min cold climate speed	10.0	0.0	100.0	%
S	S018	Source fan: cold climate speed at start-up	50.0	0.0	100.0	%
S	S019	Source fan: cold climate speed at start-up time	5	0	300	s

5.14 Free cooling

The free cooling (FC) function can be enabled only on chiller units.
The type of free cooling is configured by parameter, and may be:

- air free cooling, on air/water units equipped with air-water heat exchanger coils upstream of the condenser coils and with modulating fan control;
- remote air free cooling (see the specific paragraph);
- water free cooling, on water/water units with mixing of the source water or via water-water heat exchanger upstream of the evaporator and a 3-way modulating valve on the free cooling circuit.

User	Code	Description	Def	Min	Max	UOM
S	U068	Free cooling: enable 0/1=no/yes	0	0	1	-
S	U069	Free cooling: activation differential	3.0	0.0	99.9	K
S	U070	Free cooling: hysteresis	1.5	0.0	99.9	K
S	U071	Design free cooling delta T	8.0	0.0	99.9	K
S	U072	Water free cooling: valve closing threshold	5.0	-999.9	999.9	°C
S	U073	Water free cooling: valve closing differential	3.0	0.0	99.9	K
M	U074	Free cooling type 0=Air 1=Remote coil 2=Water	0	0	2	-

Free cooling is enabled when the outside source temperature is sufficiently lower than the temperature of the water entering the unit, as shown in the following figure:

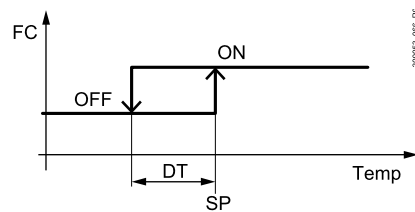

Fig.5.s

Key

FC	Free cooling
DT	Hysteresis
SP	Activation differential
Temp	User return temperature - outside source temp.

On air/water units, the fans are controlled based on the condensing temperature as long as the circuit's compressor is on; as soon as the compressor stops, the free cooling fan is controlled so as to maintain the desired water temperature set point.

5.15 Types of free cooling

5.15.1 Condensing unit with common air circuit

Free cooling is enabled based on the comparison between the user return water temperature and the outside air temperature; this directly controls switching of the three-way valve, which allows the water returning from the user terminals to flow through the free cooling coil before entering the evaporator. Free cooling capacity is controlled by modulating the fan speed (with the compressors off); in combined operation (free cooling + mechanical cooling), fan speed is controlled so as to correctly manage the condensing stage.

Inputs used:

To enable free cooling:

- User return temperature;
- Outside air temperature;

To manage capacity in free cooling mode:

- (according to the control probe used) Return/delivery water temp.



Outputs used:

- o 0-10 V to manage the common fan between free cooling and condenser;
- o Free cooling valve On-Off control.

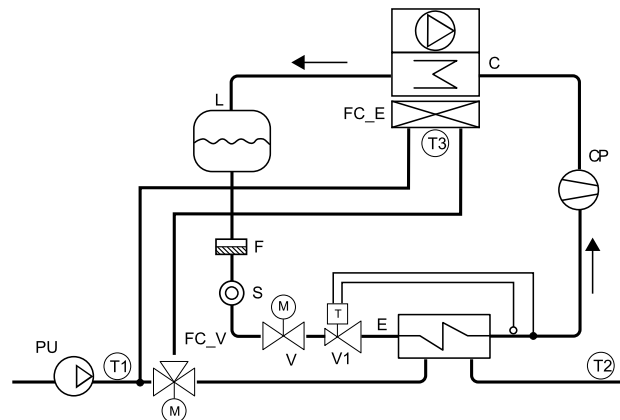

Fig.5.t

Ref.	Description	Ref.	Description
FC_E	Free cooling heat exchanger	FC_V	Free cooling valve
C	Condenser	PU	User pump
E	Evaporator	T1	User return probe
F	Filter-drier	T2	User delivery probe
L	Liquid receiver	T3	Outside temperature probe
CP	Compressor	V1	Thermostatic expansion valve
S	Liquid sightglass	V	Solenoid valve

Tab.5.d

5.15.2 Air-cooled condensing unit with separate air circuit

Free cooling is enabled based on the comparison between the user return water temperature and the outside air temperature; this directly controls switching of the three-way valve, which allows the water returning from the user terminals to flow through the free cooling coil before entering the evaporator. Free cooling capacity is controlled by modulating the specific fan speed; in combined operation (free cooling + mechanical cooling), free cooling fan speed is always 100%.

Inputs used:

To enable free cooling:

- o User return temperature;
- o Outside air temperature;

To manage capacity in free cooling mode:

- o (according to the control probe used) Return/delivery water temp.

Outputs used:

- o 0-10 V to manage the condenser fan (Y1: Master and Slave)
- o 0-10 V to manage the free cooling fan (Y2: Master);
- o Free cooling valve On-Off control.

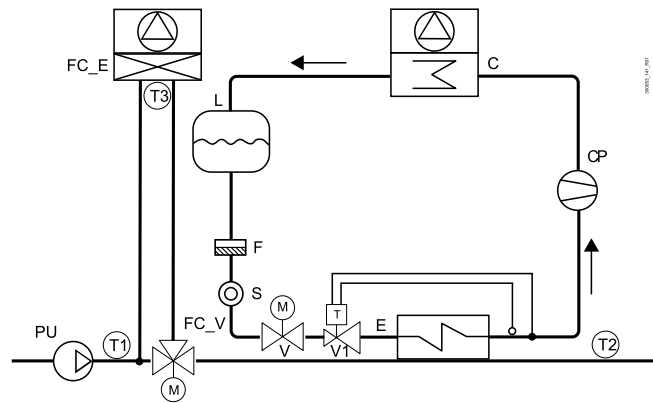

Fig.5.u

Ref.	Description	Ref.	Description
FC_E	Free cooling heat exchanger	FC_V	Free cooling valve
C	Condenser	PU	User pump
E	Evaporator	T1	User return probe
F	Filter-drier	T2	User delivery probe
L	Liquid receiver	T3	Outside temperature probe
CP	Compressor	V1	Thermostatic expansion valve
S	Liquid sightglass	V	Solenoid valve

Tab.5.e

5.15.3 Water-cooled condensing unit

Free cooling is enabled based on the comparison between the user return water temperature and the source water temperature (Temp. IN source); this controls modulation of the three-way valve that mixes the source water with the water returning from the user terminals through the free cooling coil before entering the evaporator.

Free cooling capacity is controlled by modulating the three-way free cooling valve; in combined operation (free cooling + mechanical cooling), the three-way free cooling valve is always open at 100%.

Inputs used:

To enable free cooling:

- User return temperature;
- Source inlet temperature;

To manage capacity in free cooling mode:

- (according to the control probe used) Return/delivery water temp.

Outputs used:

- 0-10 V to manage the condenser fan
- 0-10 V to manage the free cooling valve.

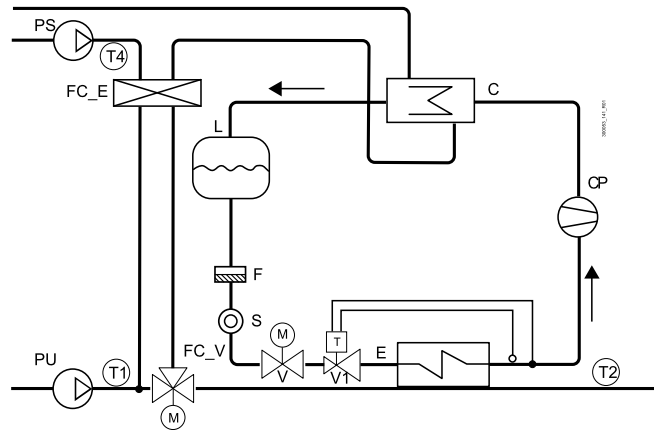
Fig.5.v

Ref.	Description	Ref.	Description
FC_E	Free cooling heat exchanger	V	Solenoid valve
C	Condenser	FC_V	Free cooling valve
E	Evaporator	PU	User pump
F	Filter-drier	PS	Source pump
L	Liquid receiver	T1	User return probe
CP	Compressor	T2	User delivery probe
FC_E	Free cooling heat exchanger	T4	Source return probe
S	Liquid sightglass	V1	Thermostatic expansion valve

Tab.5.f

5.16 Free cooling functions

5.16.1 Dynamic control gain

This special function manages the balancing of capacity between the free cooling coil and the evaporator: this optimises control stability and fluidity.

User	Code	Description	Def	Min	Max	UOM
S	U070	Free cooling: hysteresis	1.5	0.0	99.9	K
S	U069	Free cooling: activation differential	3.0	0.0	99.9	K
S	U071	Design free cooling delta T	8.0	0.0	99.9	K

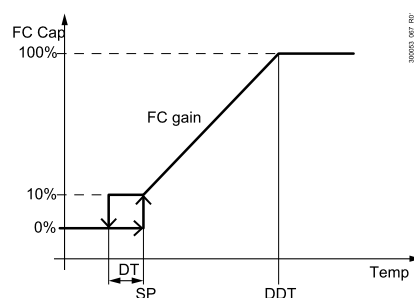
Fig.5.w

Key	
FC Cap	Free cooling capacity
DT	Hysteresis
SP	Activation differential

Key	
DDT	Design free cooling delta T
Temp.	User return temp. - source temp.

The diagram shows the ideal behaviour of free cooling control (FC) in relation proportionally to its capacity; "Design free cooling delta T" is the temperature difference (water inlet - source) needed to cover the rated unit capacity using the free cooling coil only.

The value obtained - "FC gain" - is used to adapt the control ramp to the various cooling sources, as shown in the figure.

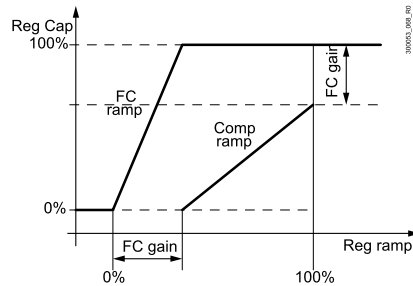

Fig.5.x

Key	
Reg Cap	Control capacity
FC ramp	Free cooling control ramp
FC gain	Dynamic gain of free cooling control
Comp ramp	Compressor control ramp
Reg ramp	Control ramp

The result is a perfect balance between the cooling capacities of the free cooling coil and the evaporator, in order to maintain the same proportionality in all load conditions. In other words, the same percentage of capacity is obtained for the same temperature variation in any load condition.

5.16.2 Effectiveness control

µChiller uses this function to start the compressors when the free cooling coil alone cannot bring the water to the set point, despite the fact that the source conditions theoretically allow for free cooling operation only. When this occurs, there may be a malfunction on the devices activated during free cooling; the compressors thus need to be started and free cooling disabled in order to ensure unit operation.

This situation is signalled by the "Free cooling warning".

5.16.3 Valve anti-block management

To avoid mechanical blocking of the valve, when a position (closed or open) is kept for more than a week, the valve is moved for 30 seconds to the opposite position.

During heat pump operation on air/water units, the outdoor coil works as an evaporator. If the outside temperature is low, frost may form on the coil, resulting in reduced unit efficiency. To free the coil from frost and restore maximum efficiency, µChiller activates the defrost function. Activation depends on the value read by the reference probe (pressure transducer, low pressure side -> evaporation temperature in the graph), on the activation threshold being exceeded, and a possible delay.

5.17 Defrost

User	Code	Description	Def	Min	Max	UOM
S	S039	Defrost: start temperature	-1.0	-99.9	99.0	°C
S	S040	Defrost: reset start defrost delay threshold	1.0	S039	99.9	°C
S	S041	Defrost: delay at start-up	30	0	999	min
S	S042	Defrost: end temperature	52.0	-999.9	999.9	°C



User	Code	Description	Def	Min	Max	UOM
S	S046	Defrost: min duration	1	0	99	min
S	S047	Defrost: max duration	5	0	99	min

Example of defrost activation:

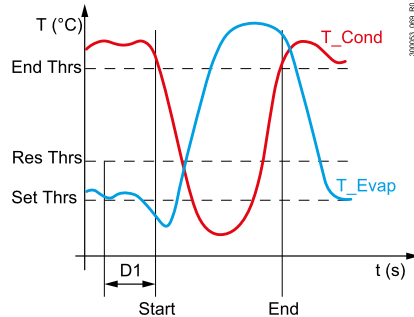

Fig.5.y

Key

T	Temperature
End Thrs	End defrost temperature
Res Thrs	Reset start defrost delay threshold
Set Thrs	Start defrost temperature
D1	Defrost start delay
Start	Start defrost
End	End defrost
T_Cond	Condensing temperature
T_Evap	Evaporation temperature

If the defrost temperature does not exceed the reset threshold during the defrost start delay, then the defrost starts. It ends when the reference probe (pressure transducer, high pressure side -> condensing temperature in the graph) exceeds the end defrost temperature or the maximum defrost duration has elapsed.

Note: for optimal defrost management, it is recommended to set the start defrost temperature to the evaporation temperature value at which ice starts forming on the coil (-1.0°C / -1.5°C); the defrost start delay expresses the time needed to accumulate a layer of ice that requires defrosting (30-60 minutes). Also see the paragraph "Sliding defrost".

5.17.1 Defrost procedure

Note: in the following description:

- "case with compressor ON" indicates that the phase is only featured if defrost is set with the compressor On;
- "case with compressor off" indicates that the phase is only featured if defrost is set with the compressor Off;

End defrost can be managed in two ways:

- with the compressor off: the thermal inertia of the condenser is used to end the defrost;
- with the compressor on: to make the defrost as fast as possible.

User	Code	Description	Def	Min	Max	UOM
M	S055	Compressor after defrost 0/1=On/Off	0	0	1	-

Compressor off at end defrost:

Compressor on for the entire defrost

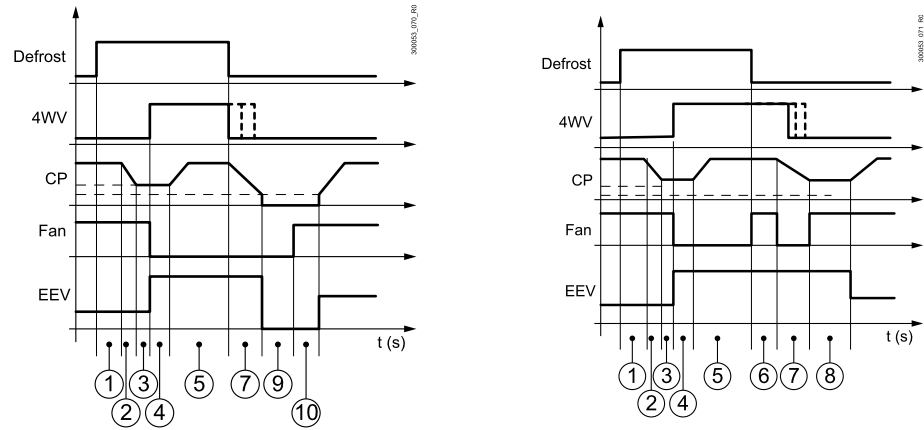

Fig.5.z

Key

Defrost	Defrost request
4WV	Cycle reversal (4-way valve)
CP	Compressor capacity
Fan	Enable fans
EEV	Electronic expansion valve

The control phases are described below.

Synchronisation (1)

Once the defrost start condition is true, there is a fixed delay of 10 s to check whether the other circuit requires defrosting, so as to carry out a simultaneous defrost if needed.

User	Code	Description	Def	Min	Max	UOM
S	S053	Defrost synchronisation 0=Independent 1=Separate 2=Simultaneous	40.0	0.0	999.9	rps

Decrease capacity to start defrosting (2)

In this phase, the circuit with BLDC compressor decreases capacity to the minimum set value; with on-off compressors, one compressor is stopped.

User	Code	Description	Def	Min	Max	UOM
S	S052	BLDC compressor speed for cycle reversing in defrost	40.0	0.0	999.9	rps

Waiting time before reversing the cycle (3)

The compressor remains at the cycle-reversal speed for a set time: with the BLDC compressor, the duration of this phase is increased by the time needed to reach minimum speed. The other control devices, such as the cycle reversing valve and the fans, continue to operate in heat pump mode.

User	Code	Description	Def	Min	Max	UOM
S	S044	Operation time at min capacity before cycle reversing	20	0	999	s

Cycle reversal and waiting time after reversal (4)

The 4-way valve is positioned in chiller mode to run the defrost, the fans are stopped and the compressor remains at the cycle-reversal speed for 5 seconds. Normally during this phase the electronic expansion

valve tends to close, due to low superheat. As a result it is forced to the maximum opening so as to guarantee a constant flow of refrigerant and maximum defrost capacity.

Defrosting (5)

The actual defrosting procedure starts: the compressor delivers full capacity so as to defrost the outdoor coil. In this phase, the BLDC compressor goes to the speed set by the corresponding parameter, the electronic expansion valve remains at the maximum opening and the fans remain off. The minimum/maximum defrost time and minimum time between two consecutive defrosts start counting in this phase.

User	Code	Description	Def	Min	Max	UOM
S	S046	Defrost: min duration	1	0	99	min
S	S047	Defrost: max duration	5	0	99	min
S	S050	Minimum delay between consecutive defrosts	20	0	999	min
S	S051	BDLC compressor speed in defrost	80.0	0.0	999.9	rps

The minimum defrost time protects compressors and circuit components from transients with high dynamics that are too close together. The maximum defrost time is a safety feature that avoids any abnormal conditions (end defrost threshold not reached - e.g. due to strong winds) that would stop the production of hot water required by the user terminals. The minimum time between consecutive defrosts is needed to prevent the unit from defrosting too frequently and thus only partly meeting demand. The actual defrosting procedure therefore ends after a maximum time or when the set condensing temperature is reached. If the compressor stops during this phase, the counters are reset.

Dripping (case with compressor on) (6)

In this phase, the compressor remains on at the defrost speed, the electronic valve is opened to the maximum and the fans are started at maximum speed, and remain at this speed for the entire dripping phase. The duration of the dripping phase can be set.

User	Code	Description	Def	Min	Max	UOM
S	S048	Dripping: duration	90	0	999	s

Decreased compressor capacity to end defrost (7)

Circuit capacity is reduced to the minimum and the cycle is reversed. In this phase, the fans are stopped (they are only activated if necessary for high pressure prevention) and the cycle reversing valve is moved to the heat pump position, controlled based on the difference between discharge and suction pressure: as soon as this pressure difference falls below the minimum differential for valve activation + 1 bar, the cycle is reversed (return to heat pump mode). If the reversing threshold is not reached, the cycle is reversed after a fixed time (60 s). The electronic expansion valve is opened to the maximum position.

User	Code	Description	Def	Min	Max	UOM
M	S054	4-way valve: pressure differential for reversing	3.0	0.0	999.9	bar

Waiting after cycle reversal (case with comp. ON) (8)

After reversing the cycle, there is a waiting time to ensure the correct flow of refrigerant; in this phase too, the ExV remains in the 100% open position.

User	Code	Description	Def	Min	Max	UOM
S	S045	Operation time at min capacity after cycle reversing	30	0	999	s

Dripping (case with comp. OFF) (9)

In this phase, the compressors, the electronic expansion valve and the fans are stopped, waiting for the coil to complete defrosting due to thermal inertia and stop dripping. The duration of the dripping phase can be set.

User	Code	Description	Def	Min	Max	UOM
S	S048	Dripping: duration 0=Dripping not performed	90	0	999	s

Post-dripping phase (case with comp. OFF) (10)

During this phase, the fans are started at 100% speed to completely expel any water still on the coil. The duration of the post-dripping phase can be set. At the end of the post-dripping phase, the circuit is reactivated in normal heat pump operation.

User	Code	Description	Def	Min	Max	UOM
S	S049	Post-dripping: duration 0=Post-dripping not performed	30	0	999	s

Quick start phase (case with comp. OFF) (11)

The compressor restarts based on the control request and the unit returns to normal operation. The start-up time is reduced so as to quickly bring compressor speed in line with the request.

User	Code	Description	Def	Min	Max	UOM
S	S056	BLDC smart start: duration (*)	20	0	999	s

(*) Shortened compressor start-up after defrost

This action assumes that the compressor has been off for a very short time, and therefore does not require complete preheating as is the case during normal start-up.

During the defrost phase (when the unit is in chiller mode), the fans are started if the condensing pressure exceeds the high condensing pressure alarm threshold - 5K.

User	Code	Description	Def	Min	Max	UOM
M	C017	Max high pressure threshold (HP)	65.0	0.0	999.9	°C

5.17.2 Sliding defrost

As the water vapour content in the air decreases as the outside temperature decreases, the time needed for a layer of ice to form that requires defrosting increases proportionally as the outside temperature decreases. Consequently, a function has been added, enabled when the outside air probe is available, which extends the defrost delay time, as shown in the following figure.

➔ **Note:** the outside probe can be connected to inputs S3/S6 (setting: source/external temperature)

User	Code	Description	Def	Min	Max	UOM
M	Hc00	S3 configuration 0=Not used 1=Source/ external temp. 2=Discharge temp. 3=Suction temp.	0	0	1	-
M	Hc03	S6 configuration 0=Not used 1=Remote set point 2=Source/external temperature 3=Reserved	0	0	3	-
S	S041	Defrost: delay at start-up	30	0	999	min
S	S043	Enable sliding defrost 0/1=No/Yes	0	0	1	-

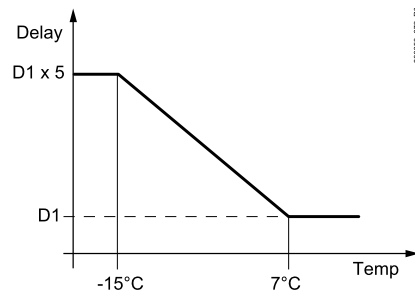

Fig.5.aa

Key

Delay	Calculated defrost start delay
D1	Defrost start delay
D1 x 5	Maximum defrost delay (5 x D1)
Temp	Outside air temperature

5.17.3 Defrost synchronisation

On two-circuit units, the defrosting procedures can be synchronised.

User	Code	Description	Def	Min	Max	UOM
S	S053	Defrost synchronisation 0=Independent 1=Separate 2=Simultaneous	0	0	2	-

Independent

The two circuits start defrosting when the conditions are right, independently of each other. In other words, there is no synchronisation and the circuits can defrost at the same time.

Separate

When the first circuit requires defrosting:

- it starts the defrost procedure;
- the other continues to work in heat pump mode.

When the first circuit has finished defrosting, the other is free to start .

Simultaneous

This procedure is used if the air flow cooling the condenser coils on one circuit affects the other: during the defrost phase this would mean a considerable waste of energy to recover the heat lost in the air flow on the other circuit. The first circuit that requires defrosting thus puts the entire unit into defrost mode. If only one circuit starts defrosting, it completes all the defrost phases while the other remains off. If the other circuit one requires defrosting but is waiting until the defrost start delay elapses, the delay is ignored and the circuit also starts defrosting. When one of the circuits reaches the end defrost condition, it remains in the dripping phase until the other circuit ends the procedure. In this way, the dripping phase is performed by both circuits, preventing the air flow to the condenser coils from affecting the defrost procedure. During this phase, the compressor is stopped instead of operating at end defrost capacity, to prevent the waiting phase of the other compressor from bringing the user terminals to excessively low temperatures.

➔ **Note:** if there is a common air circuit for the condensers, simultaneous defrosting is enabled automatically.

5.18 4-way valve management

A special function has been included to ensure correct control of the 4-way valve that reverses the refrigerating cycle. When there is a request to reverse the valve, the controller checks whether the pressure difference is higher than a threshold before activating the valve: if the difference is lower, the application waits until the compressor starts and then activates the valve when the pressure difference is reached.

User	Code	Description	Def	Min	Max	UOM
M	S054	4-way valve: pressure differential for reversing	3.0	0.0	999.9	bar

In the event of a power failure, the controller realigns the 4-way valve with the physical position of the valve at next start-up, considering the status of the circuit at the time of the power failure.

5.19 Manual device management

In the menu relating to the individual devices, operation of the individual actuators fitted on the unit can be switched from automatic to manual. For digital outputs, the options are ON or OFF, while analogue outputs can be set from 0 to 100%; the default values are all Auto.

User	Code	Description	Def	Min	Max	UOM
S	E000	ExV circuit 1: manual mode 0/1=No/Yes	0	0	1	-
S	E001	ExV circuit 1: steps in manual mode	0	0	65535	steps
S	E002	ExV circuit 2: manual mode 0/1=No/Yes	0	0	1	-
S	E003	ExV circuit 2: steps in manual mode	0	0	65535	steps
S	U002	User pump 1: operating mode 0=AUTO; 1=OFF; 2=ON	0	0	2	-
S	U005	User pump 2: operating mode 0=AUTO; 1=OFF; 2=ON	0	0	2	-
S	C002	Comp. 1 circuit 1: operating mode 0=AUTO; 1=OFF; 2=ON	0	0	2	-
S	C005	Comp. 2 circuit 1: operating mode 0=AUTO; 1=OFF; 2=ON	0	0	2	-
S	C008	Comp. 2 circuit 1: operating mode 0=AUTO; 1=OFF; 2=ON	0	0	2	-
S	C011	Comp. 2 circuit 2: operating mode 0=AUTO; 1=OFF; 2=ON	0	0	2	-
S	S002	Source pump 1: operating mode 0=AUTO; 1=OFF; 2=ON	0	0	2	-
S	S011	Source modulating fan circuit 1: operating mode 0=AUTO; 1=0%; 2=1%, ..; 101=100%	0	0	101	-
S	S014	Source ON/OFF fan 1 circuit 2: operating mode 0=AUTO; 1=OFF; 2=ON	0	0	2	-
S	S015	Source modulating fan circuit 2: operating mode 0=AUTO; 1=0%; 2=1%, ..; 101=100%	0	0	101	-

These operations bypass temperature control, but not the alarm thresholds set to protect unit safety; in general, these operations are used to test the individual actuators during installation. Manual operation of the devices is described below:

Device	Notes
Compressors	Safety times taken into account All compressor alarms are enabled
User pumps	Pump overload and flow alarm active
Source pump	-
Defrost	-
Source fans	Speed-up disabled
ExV	All alarms disabled

6. Parameter table

ⓘ **Note:** Levels: U=User; S=Service; M=Manufacturer; Display: the x indicates that the parameter can be accessed from the display terminal.

6.1 System

User	Display	Code	Description	Def.	Min.	Max.	UOM	R/W	Modbus
Plt = System									
S		U000	User pump 1: maintenance hour threshold (x100)	99	0	999	h	R/W	HR002
S		U001	User pump 1: reset hour counter	0	0	1	-	R/W	CS000
S	x	U002	User pump 1: operating mode 0=AUTO 1=OFF 2=ON	0	0	2	-	R/W	HR003
S		U003	User pump 2: maintenance hour threshold (x100)	99	0	999	h	R/W	HR004
S		U004	User pump 2: reset hour counter	0	0	1	-	R/W	CS001
S	x	U005	User pump 2: operating mode 0=AUTO 1=OFF 2=ON	0	0	2	-	R/W	HR005
S		U006	Cooling set point: minimum limit	5.0	-99.9	999.9	°C	R/W	HR00 (2R)
S		U007	Cooling set point: maximum limit	20.0	-99.9	999.9	°C	R/W	HR00 (2R)
S		U008	Heating set point: minimum limit	30.0	0.0	999.9	°C	R/W	HR01 (2R)
S		U009	Heating set point: maximum limit	45.0	0.0	999.9	°C	R/W	HR01 (2R)
S		U010	Enable set point compensation 0/1=no/yes	0	0	1	-	R/W	CS002
S		U011	Cooling compensation: start	25.0	-99.9	999.9	°C	R/W	HR01 (2R)
S		U012	Cooling compensation: end	35.0	-99.9	999.9	°C	R/W	HR01 (2R)
S		U013	Cooling compensation: maximum value	5.0	-99.9	999.9	K	R/W	HR01 (2R)
S		U014	Heating compensation: start	5.0	-99.9	999.9	°C	R/W	HR02 (2R)
S		U015	Heating compensation: end	-10	-99.9	999.9	°C	R/W	HR02 (2R)
S		U016	Heating compensation: maximum value	5.0	-99.9	999.9	K	R/W	HR02 (2R)
S		U017	Enable time band 0/1=No/Yes	0	0	1	-	R/W	CS003
S		U018	Time band: start hours	17	0	23	h	R/W	HR027
S		U019	Time band: start minutes	30	0	59	min	R/W	HR028
S		U020	Time band: end hours	7	0	23	h	R/W	HR029
S		U021	Time band: end minutes	0	0	59	min	R/W	HR030
S		U022	Type of changeover in time band 0=Off 1=2nd set point	0	0	1	-	R/W	CS004
U	x	U023	2nd cooling set point	10.0	U006	U007	°C	R/W	HR03 (2R)
U	x	U024	2nd heating set point	35.0	U008	U009	°C	R/W	HR03 (2R)
S		U025	Remote set point: analogue input 0=0-5V 1=0-10V 2=4-20 mV	0	0	2	-	R/W	HR035
S		U026	Remote set point: min value	5.0	-99.9	999.9	°C	R/W	HR03 (2R)
S		U027	Remote set point: max value	35.0	-99.9	99.9	°C	R/W	HR03 (2R)
S		U028	Remote set point: offset	0.0	-99.9	99.9	K	R/W	HR04 (2R)
S	x	U031	High water temp. alarm: offset	10.0	0.0	99.9	K	R/W	HR04 (2R)
S	x	U032	High water temp. alarm: delay at start-up	15	0	99	min	R/W	HR051
S	x	U033	High water temp. alarm: delay in operation	180	0	999	s	R/W	HR052

User	Display	Code	Description	Def.	Min.	Max.	UOM	R/W	Modbus
S		U034	Operating mode changeover 0=Keypad 1=Digital input	0	0	1	-	R/W	CS005
S		U035	Cooling/heating changeover: delay	15	0	999	min	R/W	HR053
S		U036	Control probe at start-up 0=Return 1=Delivery	0	0	1	-	R/W	CS006
S		U037	PID control delay at start-up/operation	180	0	999	s	R/W	HR054
S		U038	Control probe in operation 0=Return 1=Delivery	1	0	1	-	R/W	CS007
S		U039	PID at start-up: Kp	6.0	0.0	999.9	-	R/W	HR05 (2R)
S		U040	PID at start-up: Ti 0: integral action disabled	180	0	999	s	R/W	HR057
S		U041	PID at start-up: Td 0: derivative action disabled	0	0	99	s	R/W	HR058
S		U042	PID in operation: Kp	10.0	0.0	999.9	-	R/W	HR05 (2R)
S		U043	PID in operation: Ti 0: integral action disabled	120	0	999	s	R/W	HR061
S		U044	PID in operation: Td 0: derivative action disabled	3	0	99	s	R/W	HR062
S		U045	User pump flow alarm: delay at start-up	10	0	999	s	R/W	HR063
S		U046	User pump flow alarm: delay in operation	3	0	99	s	R/W	HR064
S		U047	Compressor activation delay after user pump	30	0	999	s	R/W	HR065
S		U048	User pump shutdown delay after compressor	180	0	999	s	R/W	HR066
S		U049	User pump rotation time	12	0	999	h	R/W	HR067
S		U050	User side frost protection: alarm threshold	-0.8	-99.9	999.9	°C	R/W	HR06 (2R)
S		U051	User side frost protection: differential	30.0	0.0	999.9	K	R/W	HR07 (2R)
S		U052	User-side frost protection: delay time at 1K	30	0	999	s	R/W	HR072
S		U053	Unit OFF: frost protection set point	4.0	-99.9	999.9	°C	R/W	HR07 (2R)
S		U054	Unit OFF: frost protection differential	2.0	0.0	99.9	K	R/W	HR07 (2R)
S		U055	User side return temp. probe: offset	0.0	-99.9	99.9	K	R/W	HR07 (2R)
S		U056	User side delivery temp. probe: offset	0.0	-99.9	99.9	K	R/W	HR08 (2R)
S		U057	Remote alarm: input logic 0/1=NC/NO	0	0	1	-	R/W	CS008
S		U058	Cooling/heating input: logic 0/1=NO/NC	1	0	1	-	R/W	CS009
S	x	U059	Remote ON/OFF: input logic 0/1=NO/NC	1	0	1	-	R/W	CS010
S		U060	User pump flow switch: input logic 0/1=NC/NO	0	0	1	-	R/W	CS011
S		U061	User pump overload protector: input logic 0/1=NC/NO	0	0	1	-	R/W	CS012
S		U062	2nd set point: input logic 0/1=NO/NC	1	0	1	-	R/W	CS013
M		U063	User pump: output logic 0/1=NC/NO	0	0	1	-	R/W	CS014
S		U064	Global alarm relay: output logic 0/1=NC/NO	0	0	1	-	R/W	CS015
S		U065	Free cooling valve: output logic 0/1=NO/NC	0	0	1	-	R/W	CS016
M		U066	Frost protection heater: output logic 0/1=NO/NC	0	0	1	-	R/W	CS017
S		U067	Alarm relay configuration 0/1=Control alarms/All	0	0	1	-	R/W	CS018
S		U068	Free cooling: enable	0	0	1	-	R/W	CS019

User	Display	Code	Description	Def.	Min.	Max.	UOM	R/W	Modbus
			0/1=no/yes						
S		U069	Free cooling: activation differential	3.0	0.0	99.9	K	R/W	HR08 (2R)
S		U070	Free cooling: hysteresis	1.5	0.0	99.9	K	R/W	HR08 (2R)
S		U071	Design free cooling delta T	8.0	0.0	99.9	K	R/W	HR08 (2R)
S		U072	Water free cooling: valve closing threshold	5.0	-999.9	999.9°C	°C	R/W	HR09 (2R)
S		U073	Water free cooling: valve closing differential	3.0	0.0	99.9	K	R/W	HR09 (2R)
M		U074	Free cooling type 0=Air 1=Remote coil 2=Water	0	0	2	-	R/W	HR095
S		U075	Frost protection type 0=Heater 1=Pump 2=Heater/Pump	2	0	2	-	R/W	HR096
M		U076	Number of user pumps	1	1	2	-	R/W	HR097
M		U077	Type of unit 0=CH 1=HP 2=CH/HP	0	0	2	-	R/W	HR098

Tab.6.a

6.2 Compressor

User	Display	Code	Description	Def.	Min	Max	UOM	R/W	Modbus
CMP = Compressor									
S		C000	Comp. 1 circuit 1: maintenance hour threshold	99	0	999	h	R/W	HR153
S		C001	Comp. 1 circuit 1: reset hour counter	0	0	1	-	R/W	CS023
S	x	C002	Comp. 1 circuit 1: operating mode 0=AUTO 1=OFF 2=ON	0	0	2	-	R/W	HR154
S		C003	Comp. 2 circuit 1: maintenance hour threshold (x100)	99	0	999	h	R/W	HR155
S		C004	Comp. 2 circuit 1: reset hour counter	0	0	1	-	R/W	CS024
S	x	C005	Comp. 2 circuit 1: operating mode 0=AUTO 1=OFF 2=ON	0	0	2	-	R/W	HR156
S		C006	Comp. 1 circuit 2: maintenance hour threshold (x100)	99	0	999	h	R/W	HR157
S		C007	Comp. 2 circuit 1: reset hour counter	0	0	1	-	R/W	CS025
S	x	C008	Comp. 2 circuit 1: operating mode 0=AUTO 1=OFF 2=ON	0	0	2	-	R/W	HR158
S		C009	Comp. 2 circuit 2: maintenance hour threshold (x100)	99	0	999	h	R/W	HR159
S		C010	Comp. 2 circuit 2: reset hour counter	0	0	1	-	R/W	CS026
S	x	C011	Comp. 2 circuit 2: operating mode 0=AUTO 1=OFF 2=ON	0	0	2	-	R/W	HR160
M		C012	Min compressor on time	180	30	999	s	R/W	HR161
M		C013	Min compressor off time	60	30	999	s	R/W	HR162

User	Display	Code	Description	Def.	Min	Max	UOM	R/W	Modbus
M		C014	Min time between consecutive compressor starts	360	300	999	s	R/W	HR163
M		C017	Max high pressure threshold (HP)	65.0	0.0	999.9	°C	R/W	HR324 (2R)
M		C018	Min low pressure threshold (LP)	0.2	-99.9	99.9	bar	R/W	HR326 (2R)
M		C020	Maximum circuit destabilisation time	240	5	999	min	R/W	HR168
S		C022	Circuit 1: discharge temp. offset	0.0	-99.9	99.9	K	R/W	HR170 (2R)
S		C023	Circuit 1:suction temp. offset	0.0	-99.9	99.9	K	R/W	HR172 (2R)
S		C024	Circuit 2: discharge temp. offset	0.0	-99.9	99.9	K	R/W	HR174 (2R)
S		C025	Circuit 2: suction temp. offset	0.0	-99.9	99.9	K	R/W	HR176 (2R)
S		C026	Circuit 1: discharge pressure offset	0.0	-99.9	99.9	bar	R/W	HR178 (2R)
S		C027	Circuit 1: suction pressure offset	0.0	-99.9	99.9	bar	R/W	HR180 (2R)
S		C028	Circuit 1: condensing temp. offset	0.0	-99.9	99.9	K	R/W	HR182 (2R)
S		C029	Circuit 1: evaporation temp. offset	0.0	-99.9	99.9	K	R/W	HR184 (2R)
S		C030	Circuit 2: discharge pressure offset	0.0	-99.9	99.9	bar	R/W	HR186 (2R)
S		C031	Circuit 2: suction pressure offset	0.0	-99.9	99.9	bar	R/W	HR188 (2R)
S		C032	Circuit 2: condensing temp. offset	0.0	-99.9	99.9	K	R/W	HR190 (2R)
S		C033	Circuit 2: evaporation temp. offset	0.0	-99.9	99.9	K	R/W	HR192 (2R)
M		C034	HP pressure switch: input logic 0/1=NC/NO	0	0	1	-	R/W	CS027
M		C035	Compressor overload protector: input logic 0/1=NC/NO	0	0	1	-	R/W	CS028
M		C036	Compressor: output logic 0/1=NO/NC	0	0	1	-	R/W	CS029
M		C037	Suction pressure: probe type 0=0-5V 1=4-20mA	0	0	1	-	R/W	HR194
M		C038	Suction pressure probe: min value	0.0	-1.0	99.9	bar	R/W	HR195 (2R)
M		C039	Suction pressure probe: max value	17.3	0.0	99.9	bar	R/W	HR197 (2R)
M		C040	Discharge pressure: probe type 0=0-5V 1=4-20mA	0	0	1	-	R/W	HR199
M		C041	Discharge pressure probe: min value	0.0	-1.0	99.9	bar	R/W	HR200 (2R)
M		C042	Discharge pressure probe: max value	45.0	0.0	99.9	bar	R/W	HR202 (2R)
M		C044	Enable destabilisation 0/1=No/Yes	1	0	1	-	R/W	CS030
S		C045	Refrigerant 3=R407C 4=R410a 6=R290 10=R744 22=R32	0	0	30	-	R	HR205
M		C046	No. of unit circuits	1	1	2	-	R/W	HR206
M		C047	Type of compressors used 0=1 On/Off 1=2 On/Off 2=1 BLDC 3= 1 BLDC+On/Off	0	0	3	-	R/W	HR207
M		C048	Compressor rotation type 1=FIFO 2=Time	1	1	2	-	R/W	HR208

Tab.6.b

 **Note:** (1) C045 is a read-only parameter.

6.3 BLDC and Inverter

User	Display	Code	Description	Def.	Min	Max	UOM	R/W	Modbus
S		P000	Min evaporation temp: custom limit	-25.0	-99.9	999.9	°C/°F	R/W	HR335 (2R)
S		P001	Max condensing temp: custom limit	70.0	-99.9	999.9	°C/°F	R/W	HR337 (2R)
M		P003	Out of envelope alarm delay	120	0	999	s	R/W	HR340
M		P004	Low pressure differential alarm delay	60	0	999	s	R/W	HR341
M		P006	Oil recovery: min request for activation	35.0	0.0	100.0	%	R/W	HR344 (2R)
M		P007	Oil recovery: min speed for activation	35.0	0.0	999.9	rps	R/W	HR346 (2R)
M		P008	Oil recovery: comp. operating time at low speed	15	0	999	min	R/W	HR348
M		P009	Oil recovery: force comp. speed time	3	0	999	min	R/W	HR349
M		P010	Oil recovery: force comp. speed value	50.0	0.0	999.9	rps	R/W	HR350 (2R)
M		P011	Oil equalisation: solenoid valve opening time at start-up	30	0	999	s	R/W	HR352
M		P012	Oil equalisation: solenoid valve opening time	3	0	999	s	R/W	HR353
M		P013	Oil equalisation: min solenoid valve closed time	1	0	999	min	R/W	HR354
M		P014	Oil equalisation: max solenoid valve closed time	15	0	999	min	R/W	HR355
M		P015	Oil equalisation: solenoid valve closed time increment	20	0	999	min	R/W	HR356
S		P016	Oil equalisation valve: output logic 0/1=NO/NC	0	0	1	-	R/W	CS66
M		P017	Enable oil equalisation valve 0/1=No/Yes	0	0	1	-	R/W	CS67
M		P018	Enable oil recovery 0/1=No/Yes	0	0	1	-	R/W	CS68
S	x	P019	BLDC compressor: operating mode 0=AUTO; 1=0%, ... 101=100%	0	0	101	-	R/W	HR357
M		P021	Max. deltaP at start-up	900.0	0.0	2000.0	kPa	R/W	HR359 (2R)
M		P022	EVD: max pre-opening time for pressure equalisation	10	0	999	s	R/W	HR361
M		P023	EVD: pre-opening value for pressure equalisation	50.0	0.0	100.0	%	R/W	HR362 (2R)
M		P024	Start-up speed	50.0	20.0	120.0	rps	R/W	HR363 (2R)
M		P025	Custom speed: max value	120.0	0.0	999.9	rps	R/W	HR365 (2R)
M		P026	Custom speed: min value	20.0	0.0	999.9	rps	R/W	HR367 (2R)
S		P030	Skip frequency: centre point [010]	0.0	0.0	999.9	Hz	R/W	HR375 (2R)
S		P031	Skip frequency: band [011]	0.0	0.0	999.9	Hz	R/W	HR377 (2R)
M		P032	Enable motor over-temperature alarm (PTC) [027] 0/1=No/Yes	0	0	1		R/W	HR379
M		P033	Motor over-temperature delay delay (PTC) [028]	0	0	999	s	R/W	HR380
M		P034	Enable crankcase heater function 0/1=No/Yes	0	0	1		R/W	CS69
M		P035	Crankcase heater current (% rated motor current)	30.0	0.0	100.0	%	R/W	HR381 (2R)

Tab.6.c

6.4 Valve

User	Display	Code	Description	Def.	Min	Max	UOM	R/W	Modbus
EEU = Valve									
S		E000	ExV circuit 1: manual mode 0/1=No/Yes	0	0	1	-	R/W	CS020
S		E001	ExV circuit 1: steps in manual mode	0	0	65535	steps	R/W	HR099
S		E002	ExV circuit 2: manual mode	0	0	1	-	R/W	CS021

User	Display	Code	Description	Def.	Min	Max	UOM	R/W	Modbus
			0/1=No/Yes						
S		E003	ExV circuit 2: steps in manual mode	0	0	65535	steps	R/W	HR100
S	x	E004	SH in cooling: set point	6.0	-40.0	180.0	K	R/W	HR101 (2R)
S		E005	SH in cooling: Kp	15.0	0.0	800.0	-	R/W	HR103 (2R)
S		E006	SH in cooling: Ti	150.0	0.0	1000.0	s	R/W	HR105 (2R)
S		E007	SH in cooling: Td	1.0	0.0	800.0	s	R/W	HR107 (2R)
S	x	E008	SH in heating: set point	6.0	-40.0	180.0	K	R/W	HR109 (2R)
S		E009	SH in heating: Kp	15.0	0.0	800.0	-	R/W	HR111 (2R)
S		E010	SH in heating: Ti	150.0	0.0	1000.0	s	R/W	HR113 (2R)
S		E011	SH in heating: Td	1.0	0.0	800.0	s	R/W	HR115 (2R)
S		E012	LowSH in cooling: threshold	1.0	-40.0	180.0	K	R/W	HR117 (2R)
S		E013	LowSH in cooling: Ti	10.0	0.0	800.0	s	R/W	HR119 (2R)
S		E014	LowSH in heating: threshold	1.0	-40.0	180.0	K	R/W	HR121 (2R)
S		E015	LowSH in heating: Ti	10.0	0.0	800.0	s	R/W	HR123 (2R)
S		E016	LOP in cooling: threshold	-5.0	-60.0	200.0	°C	R/W	HR125 (2R)
S		E017	LOP in cooling: Ti	5.0	0.0	800.0	s	R/W	HR127 (2R)
S		E018	LOP in heating: threshold	-50.0	-60.0	200.0	°C	R/W	HR129 (2R)
S		E019	LOP in heating: Ti	5.0	0.0	800.0	s	R/W	HR131 (2R)
M		E020	MOP in cooling: threshold	30.0	-60.0	200.0	°C	R/W	HR133 (2R)
M		E021	MOP in cooling: Ti	15.0	0.0	800.0	s	R/W	HR135 (2R)
M		E022	MOP in heating: threshold	20.0	-60.0	200.0	°C	R/W	HR137 (2R)
M		E023	MOP in heating: Ti	15.0	0.0	800.0	s	R/W	HR139 (2R)
M		E024	LowSH: alarm delay time	300	0	18000	s	R/W	HR141
M		E025	LOP: alarm delay time	300	0	18000	s	R/W	HR142
M		E026	MOP: alarm delay time	300	0	18000	s	R/W	HR143
M		E032	Valve opening % at start-up (EVAP/EEV capacity ratio) in cooling	100	0	100	%	R/W	HR144
M		E033	Valve opening % at start-up (EVAP/EEV capacity ratio) in heating	100	0	100	%	R/W	HR145
M		E034	Control delay after pre-positioning	6	3	18000	s	R/W	HR146
M		E046	EVD Evolution: valve (1=CAREL EXV, ...) (*)	1	1	24	-	R/W	HR048
S		E047	ExV driver (0=Disabled, 1=Built-in, 2=EVD Evolution)	0	0	2	-	R/W	HR328

Tab.6.d

 **Note:** (*) see the EVD Evolution manual for the complete list of selectable valves.

6.5 Source

User	Display	Code	Description	Def.	Min	Max	UOM	R/W	Modbus
Src = Source									
S		S000	Source pump 1: maintenance hour threshold (x100)	99	0	999	h	R/W	HR209
S		S001	Source pump 1: reset hour counter	0	0	1	-	R/W	CS026
S	x	S002	Source pump 1: operating mode 0=AUTO 1=OFF 2=ON	0	0	2	-	R/W	HR210
S		S008	Source fan 1 circuit 1: maintenance hour threshold (X100)	99	0	999	h	R/W	HR214
S		S009	Source fan 1 circuit 1: reset hour counter	0	0	1	-	R/W	CS033
S	x	S010	Source ON/OFF fan 1 circuit 1: operating mode 0=AUTO 1=OFF 2=ON	0	0	2	-	R/W	HR215
S	x	S011	Source modulating fan circuit 1: operating mode 0=AUTO	0	0	101	-	R/W	HR216

User	Display	Code	Description	Def.	Min	Max	UOM	R/W	Modbus
			1=0% 2=1%, .. 101=100%						
S		S012	Source fan 1 circuit 2: maintenance hour threshold (X100)	99	0	999	h	R/W	HR217
S		S013	Source fan 1 circuit 2: reset hour counter	0	0	1	-	R/W	CS034
S	x	S014	Source ON/OFF fan 1 circuit 2: operating mode 0=AUTO 1=OFF 2=ON	0	0	2	-	R/W	HR218
S	x	S015	Source modulating fan circuit 2: operating mode 0=AUTO 1=0% 2=1%, .. 101=100%	0	0	101	-	R/W	HR219
S		S016	Source fan: cold climate temperature threshold	-0.5	-999.9	999.9	°C	R/W	HR220 (2R)
S		S017	Source fan: min cold climate speed	10.0	0.0	100.0	%	R/W	HR222 (2R)
S		S018	Source fan: cold climate speed at start-up	50.0	0.0	100.0	%	R/W	HR224 (2R)
S		S019	Source fan: cold climate speed at start-up time	5	0	300	s	R/W	HR226
S	x	S020	Enable noise reduction 0/1=No/Yes	0	0	1	-	R/W	CS035
S		S021	Noise reduction time band: start hours	22	0	23	h	R/W	HR167
S		S022	Noise reduction time band: start minutes	30	0	59	min	R/W	HR212
S		S023	Noise reduction time band: end hours	8	0	23	h	R/W	HR041
S		S024	Noise reduction time band: end minutes	30	0	59	min	R/W	HR042
S		S025	Source fan: noise reduction set point	45.0	0.0	999.9	°C	R/W	HR231 (2R)
S		S026	Compressor start delay after pump start	30	0	999	s	R/W	HR233
S		S027	Pump shutdown delay after compressor off	10	0	999	s	R/W	HR234
S		S028	Source fan in cooling: set point	30.0	-999.9	999.9	°C	R/W	HR235 (2R)
S		S029	Source fan in heating: set point	10.0	0.0	99.9	°C	R/W	HR237 (2R)
S		S031	Source fan in cooling: set point at start-up	45.0	0.0	999.9	°C	R/W	HR241 (2R)
S		S032	Source fan: delay at start-up in cooling	240	0	999	s	R/W	HR243
S		S034	Source fan: differential in cooling	15.0	0.0	99.9	K	R/W	HR246 (2R)
S		S035	Source fan: differential in heating	5.0	0.0	99.9	K	R/W	HR248 (2R)
S		S036	Modulating source fan: min speed value	20.0	0.0	100.0	%	R/W	HR250 (2R)
S		S037	Modulating source fan: max speed value	80.0	0.0	100.0	%	R/W	HR252 (2R)
S		S039	Defrost: start temperature	-1.0	-99.9	99.0	°C	R/W	HR254 (2R)
S		S040	Defrost: reset start defrost delay threshold	1.0	S039	99.9	°C	R/W	HR256 (2R)
S		S041	Defrost: start delay	30	0	999	min	R/W	HR258
S		S042	Defrost: end temperature	52.0	-999.9	999.9	°C	R/W	HR259 (2R)
S		S043	Enable sliding defrost 0/1=No/Yes	0	0	1	-	R/W	CS037
S		S044	Operation time at min capacity before cycle reversing	20	0	999	s	R/W	HR261
S		S045	Operation time at min capacity after cycle reversing	30	0	999	s	R/W	HR262
S		S046	Defrost: min duration	1	0	99	min	R/W	HR263
S		S047	Defrost: max duration	5	0	99	min	R/W	HR264
S		S048	Dripping: duration 0=Dripping not performed	90	0	999	s	R/W	HR265
S		S049	Post-dripping: duration 0=Post-dripping not performed	30	0	999	s	R/W	HR266
S		S050	Minimum delay between consecutive defrosts	20	0	999	min	R/W	HR267
S		S051	BLDC compressor speed in defrost	80.0	0.0	999.9	rps	R/W	HR382 (2R)
S		S052	BLDC compressor speed for cycle reversing in defrost	40.0	0.0	999.9	rps	R/W	HR384 (2R)
S		S053	Defrost synchronisation 0=Independent	0	0	2	-	R/W	HR272

User	Display	Code	Description	Def.	Min	Max	UOM	R/W	Modbus
			1=Separate 2=Simultaneous						
M		S054	4-way valve: pressure differential for reversing	3.0	0.0	999.9	bar	R/W	HR274 (2R)
M		S055	Compressor after defrost 0/1=On/Off	0	0	1	-	R/W	CS038
S		S056	BLDC smart start: duration (*)	20	0	999	s	R/W	HR278
S		S057	Source frost protection: alarm threshold	-0.8	-999.9	999.9	K	R/W	HR279 (2R)
S		S058	Source frost protection: alarm differential	30.0	0.0	999.9	K	R/W	HR281 (2R)
S		S059	Frost protection alarm delay at threshold -1K	30	0	999	s	R/W	HR283
S		S060	Source: return water/outside air temperature probe offset	0.0	-99.9	99.9	K	R/W	HR284 (2R)
M		S061	Source fan: output logic 0/1=NO/NC	0	0	1	-	R/W	CS039
M		S062	Source pump: output logic 0/1=NO/NC	0	0	1	-	R/W	CS040
S		S063	Reversing valve: output logic 0/1=NO/NC	0	0	1	-	R/W	CS041
S		S064	Type of source air circuit 0=Independent 1=Common	0	0	1	-	R/W	CS042
S		S065	Type of source fan 0/1=Modulating/ON-OFF	0	0	1	-	R/W	CS044
S		S068	Type of unit 0=Air/Water 1=Water/Water	0	0	1	-	R/W	CS046

Tab.6.e

 **Note:** (*) Shortened compressor start-up after defrost.

6.6 I/O settings

User	Display	Code	Description	Def.	Min	Max	UOM	R/W	Modbus
M		Hc00	S3 configuration 0=Not used 1=Source/ external temp. 2=Discharge temp. 3=Suction temp.	0	0	1	-	R/W	HR286
M		Hc01	S4 and S5 configuration 0=Pressure 1=Temperature	0	0	1	-	R/W	HR287
M		Hc02	Enable S4 0/1=No/Yes	1	0	1	-	R/W	CS048
M		Hc03	S6 configuration 0=Not used 1=Remote set point 2= Source/ external temp. 3=Reserved	0	0	3	-	R/W	HR288
M		Hc04	S7 configuration (DIN) 0=Not used 1=Suction temperature	0	0	1	-	R/W	HR289
M		Hc05	S6 configuration (Slave) 0=Not used	0	0	1	-	R/W	HR290

User	Display	Code	Description	Def.	Min	Max	UOM	R/W	Modbus
			1=Remote set point						
M		Hc06	ID4 configuration 0=Not used 1=Comp 2 circuit 1 overload 2=Remote ON/OFF 3=Cooling/Heating 4=2nd set point 5=Remote alarm 6=User pump 1 overload	0	0	6	-	R/W	HR291
M		Hc07	ID5 configuration 0=Not used 1=Comp. 2 circuit 1 overload 2=Remote ON/OFF 3=Cooling/Heating 4=2nd set point 5=Remote alarm 6=User pump 1 overload	5	0	6	-	R/W	HR292
M		Hc08	ID6 configuration 0=Not used 1=Comp. 2 circuit 1 overload 2=Remote ON/OFF 3=Cooling/Heating 4=2nd set point 5=Remote alarm 6=User pump 1 overload	4	0	6	-	R/W	HR293
M		Hc09	ID4 configuration (Slave) 0=Not used 1=Comp. 2 circuit 2 overload 2=Remote ON/OFF 3=Cooling/Heating 4=2nd set point 5=User pump 1 overload	0	0	5	-	R/W	HR294
M		Hc10	ID5 configuration (Slave) 0=Not used 1=Comp. 2 circuit 2 overload 2=Remote ON/OFF 3=Cooling/Heating 4=2nd set point 5=User pump 1 overload	0	0	5	-	R/W	HR295
M		Hc11	ID6 configuration (Slave) 0=Not used 1=Comp. 2 circuit 2 overload 2=Remote ON/OFF 3=Cooling/Heating 4=2nd set point 5=User pump 1 overload	0	0	5	-	R/W	HR299
M		Hc12	NO6 configuration 0=Frost protection 1=Source fan/pump	0	0	1	-	R/W	CS049
S		Hc13	Buzzer 0/1=No/Yes	0	0	1	-	R/W	CS050

Tab.6f

 **Note:** (1) Max = 3 with Panel model, Max = 2 with DIN model.

6.7 BMS port

User	Display	Code	Description	Def.	Min	Max	UOM	R/W	Modbus
S	x	Hd00	BMS: serial address	1	1	247	-	-	-
S	x	Hd01	BMS: baud rate 3=9600; 4=19200; 5=38400; 6=57600; 7=115200; 8=375000	7	3	8	-	-	-
S	x	Hd02	BMS: settings 0=8-NONE-1 1=8-NONE-2 2=8-EVEN-1 3=8-EVEN-2 4=8-ODD-1 5=8-ODD-2	1	0	5	-	-	-

Tab.6.g

6.8 Password

User	Display	Code	Description	Def.	Min	Max	UOM	R/W	Modbus
U		He00	User password	1000	0000	9999	-	-	-
S		He01	Service password	2000	0000	9999	-	-	-
M		He02	Manufacturer password	1234	0000	9999	-	-	-
M		He03	Password for profile 1	0001	0000	9999	-	-	-
M		He04	Password for profile 2	0002	0000	9999	-	-	-
M		He05	Password for profile 3	0003	0000	9999	-	-	-
M		He06	Password for profile 4	0004	0000	9999	-	-	-
M		He07	Password for profile 5	0005	0000	9999	-	-	-
M		He08	Password for profile 6	0006	0000	9999	-	-	-
M		He09	Password for profile 7	0007	0000	9999	-	-	-

Tab.6.h

6.9 Dashboard values

User	Display	Code	Description	Def.	Min	Max	UOM	R/W	Modbus
U	x	EuP1	Circuit 1: evaporation temperature (or converted value)	-	-999.9	999.9	°C	R	IR026 (2R)
U	x	EuP2	Circuit 2: evaporation temperature (or converted value)	-	-999.9	999.9	°C	R	IR034 (2R)
U		dSP1	Circuit 1: discharge pressure	-	-999.9	999.9	bar	R	IR020 (2R)
U		dSP2	Circuit 2: discharge pressure	-	-999.9	999.9	bar	R	IR028 (2R)
U	x	dSt1	Circuit 1: discharge temperature	-	-999.9	999.9	°C	R	IR012 (2R)
U	x	dSt2	Circuit 2: discharge temperature	-	-999.9	999.9	°C	R	IR016 (2R)
U	x	rUSr	User: return water temperature	-	-999.9	999.9	°C	R	IR054 (2R)
U	x	dUSr	User: delivery water temperature	-	-999.9	999.9	°C	R	IR056 (2R)
U	x	Cnd1	Circuit 1: condensing temperature (or converted value)	-	-999.9	999.9	°C	R	IR024 (2R)
U	x	Cnd2	Circuit 2: condensing temperature (or converted value)	-	-999.9	999.9	°C	R	IR032 (2R)
U		Sprb	Source: return water/air temperature		-999.9	999.9	°C	R	IR044 (2R)

User	Display	Code	Description	Def.	Min	Max	UOM	R/W	Modbus
U		ScP1	Circuit 1: suction pressure	-	-999.9	999.9	bar	R	IR022 (2R)
U		ScP2	Circuit 2: suction pressure	-	-999.9	999.9	bar	R	IR030 (2R)
U		Sct1	Circuit 1: suction temperature	-	-999.9	999.9	°C	R	IR014 (2R)
U		Sct2	Circuit 2: suction temperature	-	-999.9	999.9	°C	R	IR018 (2R)
U	x	SetA	Current set point	-	-999.9	999.9	°C	R	IR046 (2R)
U		rSPt	Remote set point	-	-999.9	999.9	°C		IR090 (2R)
U		Opn1	ExV circuit 1: position	-	0	9999	%	R	IR050
U		Opn2	ExV circuit 2: position	-	0	9999	%	R	IR053
U	x	SSH1	Circuit 1: suction superheat	-	-999.9	999.9	°C	R	IR048 (2R)
U	x	SSH2	Circuit 2: suction superheat	-	-999.9	999.9	°C	R	IR051 (2R)
S	x	Hd00	BMS: serial address	1	1	245	-		
S	x	Hd01	BMS: baud rate 3=9600 4=19200 5=38400 6=57600 7=115200 8=375000	7	3	8	-		
S	x	Hd02	BMS: settings 0=8-NONE-1 1=8-NONE-2 2=8-EVEN-1 3=8-EVEN-2 4=8-ODD-1 5=8-ODD-2	0	0	5	-		
S		H1C1	Comp. 1 circuit 1: hour counter	-	0	99999	h	R	IR004 (2R)
S		H1C2	Comp. 2 circuit 1: hour counter	-	0	99999	h	R	IR006 (2R)
S		H2C1	Comp. 2 circuit 1: hour counter	-	0	99999	h	R	IR008 (2R)
S		H2C2	Comp. 2 circuit 2: hour counter	-	0	99999	h	R	IR010 (2R)
S		HSP1	Source pump: hour counter	-	0	99999	h	R	IR036 (2R)
S		HuP1	User pump 1: hour counter	-	0	99999	h	R	IR000 (2R)
S		HuP2	User pump 2: hour counter	-	0	99999	h	R	IR002 (2R)
S		HFn1	Fan circuit 1: hour counter	-	0	99999	h	R	IR040 (2R)
S		HFn2	Fan circuit 2: hour counter	-	0	99999	h	R	IR042 (2R)
S	x	rps	BLDC speed	-	0	999.9	rps	R	IR100 (2R)
S	x	Mc	BLDC current	-	0	99.9	A	R	IR102 (2R)
S		MP	BLDC power	-	0	99.9	kW	R	IR104 (2R)
S		Drt	Current speed drive temperature	-	0	999.9	°C/°F	R	IR106 (2R)
S		AIHs1	Speed drive alarm log: last	-	0	99		R	IR108
S		AIHs2	Speed drive alarm log: second-to-last	-	0	99		R	IR109
S		AIHs3	Speed drive alarm log: third-to-last	-	0	99		R	IR110
S		AIHs4	Speed drive alarm log: fourth-to-last	-	0	99		R	IR111

Tab.6i

6.10 Settings

User	Display	Code	Description	Def.	Min	Max	UOM	R/W	Modbus
U	x	SEtC	Cooling set point	7.0	U006	U007	°C/°F	R/W	HR307 (2R)
U	x	SEtH	Heating set point	40.0	U008	U009	°C/°F	R/W	HR309 (2R)
U	x	0-1	Unit On-Off from keypad 0=OFF 1=ON	0	0	1	-	R/W	CS54
U	x	ModE	Cooling/heating from keypad 0=Cooling 1=Heating	0	0	1	-	R/W	CS55
-		RES	Reset alarms from BMS 0/1=No/Yes	0	0	1	-	R/W	CS56
S	x	DFr	Force defrost 0=No 1=Circuit 1 2=Circuit 2 3=Circuit 1 and 2	0	0	3	-	R/W	HR78
S	x	ClrH	Reset alarm log 0/1=No/Yes	0	0	1	-	R/W	CS59
S	x	UoM	Unit of measure 0=°C/barg 1=°F/psig	0	0	1	-	R/W	CS47

Tab.6j

6. Supervisor table

µChiller provides a database of supervisor variables via Modbus RTU protocol over RS485 (BMS port on the µChiller controller).

The BMS port has the following default settings:

- baud rate 115,200;
- data bits 8;
- no parity;
- stop bits 1.

See "Parameter table: BMS port" to set different values.

"Index" is the address specified in the Modbus® frame.

6.1 Coil Status

Index	Size	Ref.	Type	Min/Max	R/W	UoM	Description
0	1	U001	BOOL		R/W		U001 - User pump 1 reset hour counters
1	1	U004	BOOL		R/W		U004 - User pump 2 reset hour counters
2	1	U010	BOOL		R/W		U010 - Enable setpoint compensation (0=Disabled, 1=Enabled)
3	1	U017	BOOL		R/W		U017 - Enable scheduler (0=Disabled, 1=Enabled)
4	1	U022	BOOL		R/W		U022 - Type of scheduling (0=Switch OFF, 1=Change setpoint)
5	1	U034	BOOL		R/W		U034 - Changeover type cold/heat (0=Keyboard, 1=DIn)
6	1	U036	BOOL		R/W		U036 - Startup regulation probe (0=Return, 1=Delivery)
7	1	U038	BOOL		R/W		U038 - Run regulation probe (0=Return, 1=Delivery)
8	1	U057	BOOL		R/W		U057 - Remote alarm input logic (0=N.C., 1=N.O.)
9	1	U058	BOOL		R/W		U058 - Cool/Heat input logic (0=N.O., 1=N.C.)
10	1	U059	BOOL		R/W		U059 - Remote unit ON/OFF input logic (0=N.O., 1=N.C.)
11	1	U060	BOOL		R/W		U060 - User pump flow input logic (0=N.C., 1=N.O.)
12	1	U061	BOOL		R/W		U061 - User pump overload input logic (0=N.C., 1=N.O.)
13	1	U062	BOOL		R/W		U062 - 2nd setpoint input logic (0=N.O., 1=N.C.)
14	1	U063	BOOL		R/W		U063 - User pump output logic (0=N.O., 1=N.C.)
15	1	U064	BOOL		R/W		U064 - Global alarm relay output logic (0=N.C., 1=N.O.)
16	1	U065	BOOL		R/W		U065 - Free-Cooling valve output logic (0=N.O., 1=N.C.)
17	1	U066	BOOL		R/W		U066 - Antifreeze heater output logic (0=N.O., 1=N.C.)
18	1	U067	BOOL		R/W		U067 - Alarm relay configuration (0=Regulation alarms, 1=All alarms)
19	1	U068	BOOL		R/W		U068 - Enable Free-Cooling (0=Disabled, 1=Enabled)
20	1	E000	BOOL		R/W		E000 - ExV circ.1 enable manual mode
21	1	E002	BOOL		R/W		E002 - ExV circ.2 enable manual mode
22	1	Hd06	BOOL		R/W		Hd06 - Enable power request from BMS (0=Disabled, 1=Enabled)
23	1	C001	BOOL		R/W		C001 - Compr.1 circ.1 reset hour counters
24	1	C004	BOOL		R/W		C004 - Compr.2 circ.1 reset hour counters
25	1	C007	BOOL		R/W		C007 - Compr.1 circ.2 reset hour counters
26	1	C010	BOOL		R/W		C010 - Compr.2 circ.2 reset hour counters
27	1	C034	BOOL		R/W		C034 - High press. pressostat input logic (0=N.C., 1=N.O.)
28	1	C035	BOOL		R/W		C035 - Compr. overload input logic (0=N.C., 1=N.O.)
29	1	C036	BOOL		R/W		C036 - Compr. output logic (0=N.O., 1=N.C.)
30	1	C044	BOOL		R/W		C044 - Enable circuit destabilization (0=Disabled, 1=Enabled)
31	1	S001	BOOL		R/W		S001 - Source pump 1 reset hour counters
33	1	S009	BOOL		R/W		S009 - Source fan 1 circ.1 reset hour counters
34	1	S013	BOOL		R/W		S013 - Source fan 1 circ.2 reset hour counters
35	1	S020	BOOL		R/W		S020 - Enable low noise (0=Disabled, 1=Enabled)
37	1	S043	BOOL		R/W		S043 - Enable sliding defrost (0=Disabled, 1=Enabled)
38	1	S055	BOOL		R/W		S055 - Compr. behavior in post-defrost phase (0=Compr. is OFF, 1=Compr. is turned ON)
39	1	S061	BOOL		R/W		S061 - Source fan output logic (0=N.O., 1=N.C.)

Index	Size	Ref.	Type	Min/Max	R/W	UoM	Description
40	1	S062	BOOL		R/W		S062 - Source pump output logic (0=N.O., 1=N.C.)
41	1	S063	BOOL		R/W		S063 - Reverse valve output logic (0=N.O., 1=N.C.)
42	1	S064	BOOL		R/W		S064 - Source flow type (0=Independent, 1=Common)
44	1	S065	BOOL		R/W		S065 - Source fan type (0=Inverter, 1=ON/OFF)
46	1	S068	BOOL		R/W		S068 - Unit type (0=Air/Water, 1=Water/Water)
47	1	UoM	BOOL		R/W		UoM - Unit of measure used in display 2-Row (0=°C/bar, 1=°F/PSI)
48	1	Hc02	BOOL		R/W		Hc02 - Analog channel 4 enabling (0=Disabled, 1=Enabled)
49	1	Hc12	BOOL		R/W		Hc12 - Digital output 6 config. (0=Antifreeze, 1=Source fan / Source pump)
50	1	Hc13	BOOL		R/W		Hc13 - Enable buzzer (0=Disabled, 1=Enabled)
52	1	Ha02	BOOL		R/W		Ha02 - Sets controller internal clock (0=No set, 1=Set)
53	1	Hd03	BOOL		R/W		Hd03 - Enable NFC (0=Disabled, 1=Enabled)
54	1	UnSt	BOOL		R/W		UnSt - Unit ON/OFF command by keyboard (0=OFF 1=ON)
55	1	ModE	BOOL		R/W		ModE - Cool/Heat mode by Keyboard (0=Cool, 1=Heat)
56	1	RES	BOOL		R/W		RES - Reset active alarms by BMS net (0=NO, 1=Reset)
59	1	ClrH	BOOL		R/W		ClrH - Delete alarms log (0=No, 1=Yes)
63	1	Hd05	BOOL		R/W		Hd05 - Enable unit ON/OFF command by BMS net (0=Disabled, 1=Enabled)
64	1		BOOL		R/W		Unit ON/OFF command by BMS
66	1	P016	BOOL		R/W		P016 - Oil equalization solenoid valve circuit 1 output logic (0:On if close;1:On if open)
67	1	P017	BOOL		R/W		P017 - Enable oil equalization function
68	1	P018	BOOL		R/W		P018 - Enable oil recovery function (0=OFF, 1=ON)
69	1	P034	BOOL		R/W		P034 - Enable crancckcase heater (0=OFF, 1=ON)

Tab.6.a

6.2 Input Status

Index	Size	Ref.	Type	Min/Max	R/W	UoM	Description
0	1	A01	BOOL		R		Unit - Error in the number of retain memory writings
1	1	A02	BOOL		R		Unit - Error in retain memory writings
2	1	A03	BOOL		R		Unit - Remote alarm by digital input
3	1	A04	BOOL		R		Unit - Alarm remote set point probe broken or disconnected
4	1	A05	BOOL		R		Unit - Alarm user return water temperature probe broken or disconnected
5	1	A06	BOOL		R		Unit - Alarm user delivery water temperature probe broken or disconnected
6	1	A07	BOOL		R		Unit - Alarm tank temperature probe broken or disconnected
7	1	A08	BOOL		R		Unit - User pump 1 overload
8	1	A09	BOOL		R		Unit - User pump 2 overload
9	1	A10	BOOL		R		Unit - Flow switch alarm, no flow present with user pump 1 active
10	1	A11	BOOL		R		Unit - Flow switch alarm, no flow present with user pump 2 active
11	1	A12	BOOL		R		Unit - User pumps group alarm
12	1	A13	BOOL		R		Unit - User 1 pump maintenance
13	1	A14	BOOL		R		Unit - User 2 pump maintenance
14	1	A15	BOOL		R		Unit - High chilled water temperature
15	1	A16	BOOL		R		Unit - Alarm source return water/air temperature probe broken or disconnected
16	1	A17	BOOL		R		Unit - Source 1 pump maintenance
17	1	A18	BOOL		R		Unit - Free-cooling anomaly
18	1	A19	BOOL		R		Circuit 1 - Alarm discharge pressure probe broken or disconnected
19	1	A20	BOOL		R		Circuit 1 - Alarm condensing temperature probe broken or disconnected
20	1	A21	BOOL		R		Circuit 1 - Alarm suction pressure probe broken or disconnected
21	1	A22	BOOL		R		Circuit 1 - Alarm evaporating temperature probe broken or disconnected
22	1	A23	BOOL		R		Circuit 1 - Alarm discharge temperature probe broken or disconnected
23	1	A24	BOOL		R		Circuit 1 - Alarm suction temperature probe broken or disconnected
24	1	A25	BOOL		R		Circuit 1 - High pressure alarm by pressure switch
25	1	A26	BOOL		R		Circuit 1 - High pressure alarm by transducer
26	1	A27	BOOL		R		Circuit 1 - Low pressure alarm by transducer
27	1	A28	BOOL		R		Circuit 1 - Alarm freeze evaporation temperature
29	1	A30	BOOL		R		Circuit 1 - Overload compressor 1

Index	Size	Ref.	Type	Min/Max	R/W	UoM	Description
30	1	A31	BOOL		R		Circuit 1 - Overload compressor 2
31	1	A32	BOOL		R		Circuit 1 - Compressor 1 maintenance
32	1	A33	BOOL		R		Circuit 1 - Compressor 2 maintenance
33	1	A34	BOOL		R		Circuit 1 - Source fan 1 maintenance
34	1	A35	BOOL		R		Circuit 1 EVD - Low superheating (SH)
35	1	A36	BOOL		R		Circuit 1 EVD - Low evaporation pressure (LOP)
36	1	A37	BOOL		R		Circuit 1 EVD - Maximum evaporating pressure (MOP)
37	1	A38	BOOL		R		Circuit 1 EVD - Motor error
38	1	A39	BOOL		R		Circuit 1 EVD - Emergency closing
39	1	A40	BOOL		R		Circuit 1 EVD - Incomplete valve closing
40	1	A41	BOOL		R		Circuit 1 EVD - Offline
41	1	A42	BOOL		R		Circuit 1 Envelope - Envelope general alarm + Envelope alarm zone
42	1	A43	BOOL		R		Circuit 1 BLDC - Delta pressure greater than the allowable at startup
43	1	A44	BOOL		R		Circuit 1 BLDC - Starting failure
44	1	A45	BOOL		R		Circuit 1 BLDC - Low differential pressure
45	1	A46	BOOL		R		Circuit 1 BLDC - High discharge gas temperature
46	1	A47	BOOL		R		Circuit 1 Inverter - Offline
47	1	A48	BOOL		R		Circuit 1 Inverter - General alarm + Error code
48	1	A49	BOOL		R		Unit - Slave board is offline
49	1	A50	BOOL		R		Unit - Error in the number of retain memory writings of Slave board
50	1	A51	BOOL		R		Unit - Error in retain memory writings of Slave board
51	1	A52	BOOL		R		Circuit 2 - Alarm discharge pressure probe broken or disconnected
52	1	A53	BOOL		R		Circuit 2 - Alarm condensing temperature probe broken or disconnected
53	1	A54	BOOL		R		Circuit 2 - Alarm suction pressure probe broken or disconnected
54	1	A55	BOOL		R		Circuit 2 - Alarm evaporating temperature probe broken or disconnected
55	1	A56	BOOL		R		Circuit 2 - Alarm discharge temperature probe broken or disconnected
56	1	A57	BOOL		R		Circuit 2 - Alarm suction temperature probe broken or disconnected
57	1	A58	BOOL		R		Circuit 2 - High pressure alarm by pressure switch
58	1	A59	BOOL		R		Circuit 2 - High pressure alarm by transducer
59	1	A60	BOOL		R		Circuit 2 - Low pressure alarm by transducer
60	1	A61	BOOL		R		Circuit 2 - Alarm freeze evaporation temperature
62	1	A63	BOOL		R		Circuit 2 - Overload compressor 1
63	1	A64	BOOL		R		Circuit 2 - Overload compressor 2
64	1	A65	BOOL		R		Circuit 2 - Compressor 1 maintenance
65	1	A66	BOOL		R		Circuit 2 - Compressor 2 maintenance
66	1	A67	BOOL		R		Circuit 2 - Source fan 1 maintenance
67	1	A68	BOOL		R		Circuit 2 EVD - Low superheating (SH)
68	1	A69	BOOL		R		Circuit 2 EVD - Low evaporation pressure (LOP)
69	1	A70	BOOL		R		Circuit 2 EVD - Maximum evaporating pressure (MOP)
70	1	A71	BOOL		R		Circuit 2 EVD - Motor error
71	1	A72	BOOL		R		Circuit 2 EVD - Emergency closing
72	1	A73	BOOL		R		Circuit 2 EVD - Incomplete valve closing
73	1	A74	BOOL		R		Circuit 2 EVD - Offline
74	1	A75	BOOL		R		Circuit 2 Envelope - Envelope general alarm + Envelope alarm zone
75	1	A76	BOOL		R		Circuit 2 BLDC - Delta pressure greater than the allowable at startup
76	1	A77	BOOL		R		Circuit 2 BLDC - Starting failure
77	1	A78	BOOL		R		Circuit 2 BLDC - Low differential pressure
78	1	A79	BOOL		R		Circuit 2 BLDC - High discharge gas temperature
79	1	A80	BOOL		R		Circuit 2 Inverter - Offline
80	1	A81	BOOL		R		Circuit 2 Inverter - General alarm + Error code
81	1		BOOL		R		PrevAFreeze_C1 - Prevent request for antifreeze condition active inside circ.1
82	1		BOOL		R		PrevHP_C1 - Prevent request for high pressure condition active inside circ.1
83	1		BOOL		R		PrevAFreeze_C2 - Prevent request for antifreeze condition active inside circ.2
84	1		BOOL		R		PrevHP_C2 - Prevent request for high pressure condition active inside circ.2
102	1		BOOL		R		Comp1Circ1_On - Compr.1 circ.1 status (0=OFF 1=ON)
103	1		BOOL		R		Comp2Circ1_On - Compr.2 circ.1 status (0=OFF, 1=ON)

Index	Size	Ref.	Type	Min/Max	R/W	UoM	Description
104	1		BOOL		R		Comp1Circ2_On - Compr.1 circ.1 status (0=OFF, 1=ON)
105	1		BOOL		R		Comp2Circ2_On - Compr.2 circ.2 status (0=OFF, 1=ON)
106	1		BOOL		R		RelayAlrm - Global alarm relay
107	1		BOOL		R		CoolHeat - Unit in heating mode (0=Cooling, 1=Heating)
108	1		BOOL		R		FC_Status - Free cooling valve status (0=OFF, 1=ON)
109	1		BOOL		R		Antifreeze heater status
110	1		BOOL		R		Unit scheduler status
120	1		BOOL		R		SrcFanCirc1_On - Source fan circ.1 status (0=OFF, 1=ON)
121	1		BOOL		R		Source pump 1 status (0=OFF, 1=ON)
122	1		BOOL		R		UsrPmp1_On - User pump 1 status
123	1		BOOL		R		Reverse cycle valve circuit 1 status
124	1		BOOL		R		Oil equalization valve circuit 1 status
125	1		BOOL		R		SrcFanCirc2_On - Source fan circ.2 status (0=OFF, 1=ON)
127	1		BOOL		R		UsrPmp2_On - User pump 2 status
128	1		BOOL		R		Reverse cycle valve circuit 2 status
129	1		BOOL		R		Oil equalization valve circuit 2 status
131	1		BOOL		R		Defrost running on circuit 1
132	1		BOOL		R		Defrost running on circuit 2
134	1		BOOL		R		Unit status
143	1		BOOL		R		Compr.1 circuit 1 forced on by oil migration management
144	1		BOOL		R		Compr.2 circuit 1 forced on by oil migration management
145	1		BOOL		R		Compr.1 circuit 2 forced on by oil migration management
146	1		BOOL		R		Compr.2 circuit 2 forced on by oil migration management
148	1		BOOL		R		UsrFlw_Absent - User pump flow absent (0=Flow OK, 1=Flow absent)

Tab.6b

6.3 Holding Register

Index	Size	Ref.	Type	Min/Max	R/W	UoM	Description
2	1	U000	INT	0..999	R/W	h	U000 - User pump 1 maintenance hour threshold (x100)
3	1	U002	INT	0..2	R/W		U002 - User pump 1 manual mode (0=AUTO, 1=OFF, 2=ON)
4	1	U003	INT	0..999	R/W	h	U003 - User pump 2 maintenance hour threshold (x100)
5	1	U005	INT	0..2	R/W		U005 - User pump 2 manual mode (0=AUTO, 1=OFF, 2=ON)
7	2	U006	REAL	-99.9..999.9	R/W	°C/°F	U006 - Cool setpoint low limit
9	2	U007	REAL	-99.9..999.9	R/W	°C/°F	U007 - Cool setpoint high limit
11	2	U008	REAL	0..999.9	R/W	°C/°F	U008 - Heat setpoint low limit
13	2	U009	REAL	0..999.9	R/W	°C/°F	U009 - Heat setpoint high limit
15	2	U011	REAL	-99.9..999.9	R/W	°C/°F	U011 - Starting temp. point for cool setpoint compensation
17	2	U012	REAL	-99.9..99.9	R/W	°C/°F	U012 - Ending temp. point for cool setpoint compensation
19	2	U013	REAL	-99.9..99.9	R/W	K/R	U013 - Max compensation for cool setpoint
21	2	U014	REAL	-99.9..999.9	R/W	°C/°F	U014 - Starting temp. point for heat setpoint compensation
23	2	U015	REAL	-99.9..99.9	R/W	°C/°F	U015 - Ending temp. point for heat setpoint compensation
25	2	U016	REAL	-99.9..99.9	R/W	K/R	U016 - Max compensation for heat setpoint
27	1	U018	INT	0..23	R/W	h	U018 - Scheduler start hour time band
28	1	U019	INT	0..59	R/W	min	U019 - Scheduler start minute time band
29	1	U020	INT	0..23	R/W	h	U020 - Scheduler end hour time band
30	1	U021	INT	0..59	R/W	min	U021 - Scheduler end minute time band
31	2	U023	REAL	U006..U007	R/W	°C/°F	U023 - 2nd cool setpoint
33	2	U024	REAL	U008..U009	R/W	°C/°F	U024 - 2nd heat setpoint
35	1	U025	INT	0..2	R/W		U025 - Analog setpoint input type (0=0-5V, 1=0-10V, 2=4-20mA)
37	2	U026	REAL	-99.9..99.9	R/W	°C/°F	U026 - Remote setpoint min value
39	2	U027	REAL	-99.9..99.9	R/W	°C/°F	U027 - Remote setpoint max value
41	1	S023	INT	0..23	R/W	h	S023 - Low noise end hour time band
42	1	S024	INT	0..59	R/W	min	S024 - Low noise end minute time band

Index	Size	Ref.	Type	Min/Max	R/W	UoM	Description
43	2	U028	REAL	-99.9..99.9	R/W	K/R	U028 - Remote setpoint offset
48	1	E046	INT	1..24	R/W		E046 - ExV valve type for EVD EVO (1=CAREL EXV, ...)
49	2	U031	REAL	0..99.9	R/W	K/R	U031 - High water temp. setpoint offset
51	1	U032	INT	0..99	R/W	min	U032 - High water temp. startup delay
52	1	U033	INT	0..999	R/W	s	U033 - High water temp.run delay
53	1	U035	INT	0..999	R/W	min	U035 - Changeover delay time
54	1	U037	INT	0..999	R/W	s	U037 - Delay time between Startup PID and Run PID
55	2	U039	REAL	0..999.9	R/W		U039 - Startup PID Kp
57	1	U040	INT	0..999	R/W	s	U040 - Startup PID Ti
58	1	U041	INT	0..99	R/W	s	U041 - Startup PID Td
59	2	U042	REAL	0..999.9	R/W		U042 - Run PID Kp
61	1	U043	INT	0..999	R/W	s	U043 - Run PID Ti
62	1	U044	INT	0..99	R/W	s	U044 - Run PID Td
63	1	U045	INT	0..999	R/W	s	U045 - User pump flow alarm startup delay
64	1	U046	INT	0..99	R/W	s	U046 - User pump flow alarm run delay
65	1	U047	INT	0..999	R/W	s	U047 - Compr. delay ON since the user pump ON
66	1	U048	INT	0..999	R/W	s	U048 - User pump delay OFF since the compr. OFF
67	1	U049	INT	0..999	R/W	h	U049 - User pump rotation time
68	2	U050	REAL	-99.9..999.9	R/W	°C/°F	U050 - Antifreeze user alarm threshold
70	2	U051	REAL	0..999.9	R/W	K/R	U051 - Antifreeze user alarm differential
72	1	U052	INT	0..999	R/W	s	U052 - Antifreeze user alarm delay time at 1K below threshold
73	2	U053	REAL	-99.9..999.9	R/W	°C/°F	U053 - Antifreeze (with unit OFF) setpoint
75	2	U054	REAL	0..99.9	R/W	K/R	U054 - Antifreeze (with unit OFF) differential
78	1	DFr	INT	0..3	R/W		DFr - Force manual defrost (0= None, 1= Force defrost on circ. 1, 2= Force defrost on circ. 2, 3= Force defrost on all circuits)
79	2	U055	REAL	-99.9..99.9	R/W	K/R	U055 - Probe offset of return water temp. from user
83	2	U056	REAL	-99.9..99.9	R/W	K/R	U056 - Probe offset of delivery water temp. to user
85	2	U069	REAL	0..99.9	R/W	K/R	U069 - Delta temp. to activate Free-Cooling
87	2	U070	REAL	0..99.9	R/W	K/R	U070 - Free-Cooling ON/OFF hysteresis
89	2	U071	REAL	0..99.9	R/W	K/R	U071 - Delta temp. Free-Cooling design (to reach unit nominal capacity)
91	2	U072	REAL	-99.9..999.9	R/W	°C/°F	U072 - Free-Cooling limit threshold (used to close FC valve: because FC gives water with temp. very low)
93	2	U073	REAL	0..99.9	R/W	K/R	U073 - Free-Cooling limit differential
95	1	U074	INT	0..2	R/W		U074 - Free-Cooling type (0=Air, 1=Remote air coil, 2=Water)
96	1	U075	INT	0..2	R/W		U075 - Antifreeze type (0=Heater, 1=Pump, 2=Heater-Pump)
97	1	U076	INT	1..2	R/W		U076 - User pump number
98	1	U077	INT	0..2	R/W		U077 - Unit type (0=CH, 1=HP, 2=CH/HP)
99	1	E001	INT	0..65535	R/W	Steps	E001 - ExV circ.1 manual mode steps
100	1	E003	INT	0..65535	R/W	Steps	E003 - ExV circ.2 manual mode steps
101	2	E004	REAL	-40..180	R/W	K/R	E004 - ExV SH setpoint in cool
103	2	E005	REAL	0.800	R/W		E005 - ExV SH regulation Kp in cool
105	2	E006	REAL	0..1000	R/W	s	E006 - ExV SH regulation Ti in cool
107	2	E007	REAL	0.800	R/W	s	E007 - ExV SH regulation Td in cool
109	2	E008	REAL	-40..180	R/W	K/R	E008 - ExV SH setpoint in heat
111	2	E009	REAL	0.800	R/W		E009 - ExV SH regulation Kp in heat
113	2	E010	REAL	0..1000	R/W	s	E010 - ExV SH regulation Ti in heat
115	2	E011	REAL	0.800	R/W	s	E011 - ExV SH regulation Td in heat
117	2	E012	REAL	-40..180	R/W	K/R	E012 - ExV low SH threshold in cool
119	2	E013	REAL	0.800	R/W	s	E013 - ExV low SH Ti in cool
121	2	E014	REAL	-40..180	R/W	K/R	E014 - ExV low SH threshold in heat
123	2	E015	REAL	0.800	R/W	s	E015 - ExV low SH Ti in heat
125	2	E016	REAL	-60..200	R/W	°C/°F	E016 - ExV LOP regulation threshold in cool
127	2	E017	REAL	0.800	R/W	s	E017 - ExV LOP regulation Ti in cool
129	2	E018	REAL	-60..200	R/W	°C/°F	E018 - ExV LOP regulation threshold in heat
131	2	E019	REAL	0.800	R/W	s	E019 - EEV LOP regulation Ti in heat
133	2	E020	REAL	-60..200	R/W	°C/°F	E020 - ExV MOP regulation threshold in cool

Index	Size	Ref.	Type	Min/Max	R/W	UoM	Description
135	2	E021	REAL	0.800	R/W	s	E021 - ExV MOP regulation Ti in cool
137	2	E022	REAL	-60..200	R/W	°C/°F	E022 - ExV MOP regulation threshold in heat
139	2	E023	REAL	0.800	R/W	s	E023 - ExV MOP regulation Ti in heat
141	1	E024	INT	0..18000	R/W	s	E024 - ExV low SH alarm delay time
142	1	E025	INT	0..18000	R/W	s	E025 - ExV LOP alarm delay time
143	1	E026	INT	0..18000	R/W	s	E026 - ExV MOP alarm delay time
144	1	E032	INT	0.100	R/W	%	E032 - ExV startup valve opening % (capacity ratio EVAP / EEV) in cool
145	1	E033	INT	0.100	R/W	%	E033 - ExV startup valve opening % (capacity ratio EVAP / EEV) in heat
146	1	E034	INT	0..18000	R/W	s	E034 - ExV regulation delay after pre-positioning
153	1	C000	INT	0.999	R/W	h	C000 - Compr.1 circ.1 maintenance hour threshold (x100
154	1	C002	INT	0..2	R/W		C002 - Compr.1 circ.1 manual mode (0=AUTO, 1=OFF, 2=ON)
155	1	C003	INT	0.999	R/W	h	C003 - Compr.2 circ.1 maintenance hour threshold (x100
156	1	C005	INT	0..2	R/W		C005 - Compr.2 circ.1 manual mode (0=AUTO, 1=OFF, 2=ON)
157	1	C006	INT	0.999	R/W	h	C006 - Compr.1 circ.2 maintenance hour threshold (x100
158	1	C008	INT	0..2	R/W		C008 - Compr.1 circ.2 manual mode (0=AUTO, 1=OFF, 2=ON)
159	1	C009	INT	0.999	R/W	h	C009 - Compr.2 circ.2 maintenance hour threshold (x100
160	1	C011	INT	0..2	R/W		C011 - Compr.2 circ.2 manual mode (0=AUTO, 1=OFF, 2=ON)
162	1	C012	INT	30..999	R/W	s	C012 - Compr. min On time
163	1	C013	INT	30..999	R/W	s	C013 - Compr. min Off time
164	1	C014	INT	300..999	R/W	s	C014 - Min time between On of same compr.
167	1	S021	INT	0..23	R/W	h	S021 - Low noise start hour time band
168	1	C020	INT	5..999	R/W	min	C020 - Circuit destabilization max time with one or more compr. OFF
170	2	C022	REAL	-99.9..99.9	R/W	K/R	C022 - Discharge temp. probe offset for circ. 1
172	2	C023	REAL	-99.9..99.9	R/W	K/R	C023 - Suction temp. probe offset for circ.1
174	2	C024	REAL	-99.9..99.9	R/W	K/R	C024 - Discharge temp. probe offset for circ.2
176	2	C025	REAL	-99.9..99.9	R/W	K/R	C025 - Suction temp. probe offset for circ.2
178	2	C026	REAL	-99.9..99.9	R/W	bar/psi	C026 - Discharge press. probe offset for circ.1
180	2	C027	REAL	-99.9..99.9	R/W	bar/psi	C027 - Suction press. probe offset for circ.1
182	2	C028	REAL	-99.9..99.9	R/W	K/R	C028 - Cond. temp. probe offset for circ.1
184	2	C029	REAL	-99.9..99.9	R/W	K/R	C029 - Evap. temp. probe offset for circ.1
186	2	C030	REAL	-99.9..99.9	R/W	bar/psi	C030 - Discharge press. probe offset for circ.2
188	2	C031	REAL	-99.9..99.9	R/W	bar/psi	C031 - Suction press. probe offset for circ.2
190	2	C032	REAL	-99.9..99.9	R/W	K/R	C032 - Cond. temp. probe offset for circ.2
192	2	C033	REAL	-99.9..99.9	R/W	K/R	C033 - Evap. temp. probe offset for circ.2
194	1	C037	INT	0..1	R/W		C037 - Suction press. probe type (0=0..5V, 1=4..20mA)
195	2	C038	REAL	-1.0..99.9	R/W	bar/psi	C038 - Suction press. probe min value
197	2	C039	REAL	0.0..99.9	R/W	bar/psi	C039 - Suction press. probe max value
199	1	C040	INT	0..1	R/W		C040 - Discharge press. probe type (0=0..5V, 1=4..20mA)
200	2	C041	REAL	-1.0..99.9	R/W	bar/psi	C041 - Discharge press. probe min value
202	2	C042	REAL	0.0..99.9	R/W	bar/psi	C042 - Discharge press. probe max value
206	1	C046	INT	1..2	R/W		C046 - Number of circuit in the unit
207	1	C047	INT	0..1	R/W		C047 - Type of compressors used (0=1 ON/OFF, 1=2 ON/OFF)
208	1	C048	INT	1..2	R/W		C048 - Compressor rotation type (1=FIFO, 2=TIME)
209	1	S000	INT	0.999	R/W	h	S000 - Source pump 1 maintenance hour threshold (x100
210	1	S002	INT	0..2	R/W		S002 - Source pump 1 manual mode (0=AUTO, 1=OFF, 2=ON)
212	1	S022	INT	0..59	R/W	min	S022 - Low noise start minute time band
214	1	S008	INT	0.999	R/W	h	S008 - Source fan 1 circ.1 maintenance hour threshold (x100
215	1	S010	INT	0..2	R/W		S010 - Source fan ON/OFF circ.1 manual mode (0=AUTO, 1=OFF, 2=ON)
216	1	S011	INT	0..101	R/W	%	S011 - Source fan inverter circ.1 manual mode(0=AUTO, 1=0%, 2=1%, .. 101=100%)
217	1	S012	INT	0.999	R/W	h	S012 - Source fan 1 circ.2 maintenance hour threshold (x100
218	1	S015	INT	0..101	R/W	%	S015 - Source fan inverter circ.2 manual mode (0=AUTO, 1=0%, 2=1%, .. 101=100%)
219	1	S016	REAL	-99.9..999.9	R/W	°C/°F	S016 - Source fan temp. threshold for cold climates
220	2	S016	REAL	-99.9..999.9	R/W	°C/°F	S016 - Source fan temp. threshold for cold climates
222	2	S017	REAL	0.100	R/W	%	S017 - Source fan min speed for cold climates
224	2	S018	REAL	0.100	R/W	%	S018 - Source fan speed up speed for cold climates
226	1	S019	INT	0.300	R/W	s	S019 - Source fan speed up time for cold climates

Index	Size	Ref.	Type	Min/Max	R/W	UoM	Description
231	2	S025	REAL	0..999.9	R/W	°C/°F	S025 - Low noise source fan setpoint in cooling
233	1	S026	INT	0..999	R/W	s	S026 - Compr. delay ON since the source pump ON
234	1	S027	INT	0..999	R/W	s	S027 - Source pump delay OFF since the compr. OFF
235	2	S028	REAL	-99.9..999.9	R/W	°C/°F	S028 - Source fan cool setpoint
237	2	S029	REAL	0..99.9	R/W	°C/°F	S029 - Source fan heat setpoint
241	2	S031	REAL	0..999.9	R/W	°C/°F	S031 - Source fan cool setpoint at startup
243	1	S032	INT	0..999	R/W	s	S032 - Source fan cool startup delay
246	2	S034	REAL	0..99.9	R/W	K/R	S034 - Source fan cool differential
248	2	S035	REAL	0..99.9	R/W	K/R	S035 - Source fan heat differential
250	2	S036	REAL	0..100	R/W	%	S036 - Source fan inverter min speed
252	2	S037	REAL	0..100	R/W	%	S037 - Source fan inverter max speed
254	2	S039	REAL	-99.9..99.9	R/W	°C/°F	S039 - Defrost start threshold
256	2	S040	REAL	S039..99.9	R/W	°C/°F	S040 - Defrost start threshold reset
258	1	S041	INT	0..999	R/W	min	S041 - Defrost start delay
259	2	S042	REAL	-99.9..999.9	R/W	°C/°F	S042 - Defrost end threshold
261	1	S044	INT	0..999	R/W	s	S044 - Defrost begin delay before actuating the 4 way valve
262	1	S045	INT	0..999	R/W	s	S045 - Defrost ending delay after actuating the 4 way valve
263	1	S046	INT	0..99	R/W	min	S046 - Defrost min duration
264	1	S047	INT	0..99	R/W	min	S047 - Defrost max duration
265	1	S048	INT	0..999	R/W	s	S048 - Dripping duration
266	1	S049	INT	0..999	R/W	s	S049 - Post dripping duration
267	1	S050	INT	0..999	R/W	min	S050 - Delay between defrosts
272	1	S053	INT	0..2	R/W		S053 - Defrost synchronization type (0=Independent, 1=Separated, 2=Simultaneous)
274	2	S054	REAL	0..999.9	R/W	bar/psi	S054 - Delta press. to reverse the 4 way valve
278	1	S056	INT	0..999	R/W	s	S056 - Duration of smart start function
279	2	S057	REAL	-99.9..999.9	R/W	°C/°F	S057 - Antifreeze source alarm threshold
281	2	S058	REAL	0..999.9	R/W	K/R	S058 - Antifreeze source alarm differential
283	1	S059	INT	0..999	R/W	s	S059 - Antifreeze source alarm delay time at 1K below threshold
284	2	S060	REAL	-99.9..99.9	R/W	K/R	S060 - Probe offset of Return water/Air temp. from source
286	1	Hc00	INT	0..3	R/W		Hc00 - Analog input 3 config. (0=Not used, 1=Source temp., 2=Discharge temp., 3=Suction temp.)
287	1	Hc01	INT	0..1	R/W		Hc01 - Analog input 4 and 5 config. (0=Pressure, 1=Temp.)
288	1	Hc03	INT	0..3	R/W		Hc03 - Analog input 6 config. (0=Not used, 1=Remote setpoint, 2=Source temp.)
289	1	Hc04	INT	0..1	R/W		Hc04 - Analog input 7 config.(0=Not used, 1=Suction temp.)
290	1	Hc05	INT	0..1	R/W		Hc05 - Analog input 6 config. of Slave board (0=Not used, 1=Remote setpoint)
291	1	Hc06	INT	0..6	R/W		Hc06 - Digital input 4 config. (0=Not used, 1=Compr.2 circ.1 overload, 2=Remote ON/OFF, 3=Cool/Heat, 4=2nd SetPoint, 5=Remote alarm , 6=User pump 1 overload)
292	1	Hc07	INT	0..6	R/W		Hc07 - Digital input 5 config. (0=Not used, 1=Compr.2 circ.1 overload, 2=Remote ON/OFF, 3=Cool/Heat, 4=2nd SetPoint, 5=Remote alarm , 6=User pump 1 overload)
293	1	Hc08	INT	0..6	R/W		Hc08 - Digital input 6 config. (0=Not used, 1=Compr.2 circ.1 overload, 2=Remote ON/OFF, 3=Cool/Heat, 4=2nd SetPoint, 5=Remote alarm , 6=User pump 1 overload)
294	1	Hc09	INT	0..5	R/W		Hc09 - Digital input 4 config. of Slave board (0=Not used, 1=Compr.2 circ.2 overload, 2=Remote ON/OFF, 3=Cool/Heat, 4=2nd SetPoint, 5=User pump 1 overload)
295	1	Hc10	INT	0..5	R/W		Hc10 - Digital input 5 config. of Slave board (0=Not used, 1=Compr.2 circ.2 overload, 2=Remote ON/OFF, 3=Cool/Heat, 4=2nd SetPoint, 5=User pump 1 overload)
296	1	Hc11	INT	0..5	R/W		Hc11 - Digital input 6 config. of Slave board (0=Not used, 1=Compr.2 circ.2 overload, 2=Remote ON/OFF, 3=Cool/Heat 4=2nd SetPoint, 5=User pump 1 overload)
307	2	SEtC	REAL	U006..U007	R/W	°C/°F	SEtC - Cool setpoint
309	2	SEtH	REAL	U008..U009	R/W	°C/°F	SEtH - Heat setpoint
324	2	C017	REAL	0..999.9	R/W	°C/°F	C017 - Threshold of max high pressure (HP)
326	2	C018	REAL	-99.9..99.9	R/W	bar/psi	C018 - Threshold of min low pressure (LP)
328	1	E047	INT	0..2	R/W		E047 - Type of ExV driver (0= Disabled, 1= EVD embedded, 2=EVD EVO)
331	2		REAL	0.0... 100.0	R/W	%	Power request value from BMS
335	2	P000	REAL	-99.9..999.9	R/W	°C/°F	P000 - Evaporating min temp. custom envelop limit
337	2	P001	REAL	-99.9..999.9	R/W	°C/°F	P001 - Condensing max temp. custom envelop limit
340	1	P003	UINT	0..999	R/W	s	P003 - Out of envelop alarm delay time
341	1	P004	UINT	0..999	R/W	s	P004 - Low pressure difference alarm delay
344	2	P006	REAL	0..100	R/W	%	P006 - Oil recovery min request for activation

Index	Size	Ref.	Type	Min/Max	R/W	UoM	Description
346	2	P007	REAL	0..999.9	R/W	rps	P007 - Oil recovery min compr. speed for activation
348	1	P008	UINT	0..999	R/W	min	P008 - Oil recovery time before activation in which the compr. can run at min speed
349	1	P009	UINT	0..999	R/W	min	P009 - Oil recovery duration in which the compr. speed is forced
350	2	P010	REAL	0..999.9	R/W	rps	P010 - Oil recovery compr. speed in which the compr. is forced
352	1	P011	UINT	0..999	R/W	s	P011 - Oil equalization startup time of solenoid valve on compressor starts
353	1	P012	UINT	0..999	R/W	s	P012 - Oil equalization solenoid valve open time
354	1	P013	UINT	(0..999)	R/W	min	P013 - Oil equalization solenoid valve minimum off time
355	1	P014	UINT	(0..999)	R/W	min	P014 - Oil equalization solenoid valve maximum off time
356	1	P015	UINT	(0..999)	R/W	min	P015 - Oil equalization maximum time for the management
357	1	P019	USINT	0..101	R/W		P019 - Compressor 1 circuit 1 manual mode (0=AUTO, 1=0%, ... 101=100%)
359	2	P021	REAL	0..2000	R/W	kPa	P021 - Max permitted Delta P to start up
361	1	P022	UINT	0..999	R/W	s	P022 - Max time of EVD propening to equalize pressure
362	1	P023	UINT	0..100	R/W	%	P023 - Preopening of EVD in case of prestart to equalize pressure
363	2	P024	REAL	0..999.9	R/W	rps	P024 - Start up speed
365	2	P025	REAL	0..999.9	R/W	rps	P025 - Max speed custom (rps)
367	2	P026	REAL	0..999.9	R/W	rps	P026 - Min speed custom (rps)
369	2	P027	REAL	0..100	R/W	%	P027 - BLDC speed request threshold % to call on it
371	2	Cb39	REAL	20.0..120.0	R/W	rps	P028 - BLDC speed threshold to call on fixed speed compressor
373	2	Cb40	REAL	20.0..120.0	R/W	rps	P029 - BLDC speed threshold to switch off fixed speed compressor
375	2	P030	REAL	0..999.9	R/W	Hz	P030 - Skip frequency: set 1 [010]
377	2	P031	REAL	0..999.9	R/W	Hz	P031 - Skip frequency: band 1 [011]
379	1	P032	UINT	0..1	R/W		P032 - Enable motor overtemperature alarm (PTC) (0=OFF, 1=ON) [027]
380	1	P033	UINT	0..999	R/W	s	P033 - Motor overtemperature alarm delay [028]
381	2	P035	REAL	0..100.0	R/W	%	P035 - Crankcase heater current set (% of motor rated current)
383	2	S051	REAL	20.0..120.0	R/W	rps	S051 - BLDC defrost speed
385	2	S052	REAL	20.0..120.0	R/W	rps	S052 - BLDC cycle reverse speed in defrost

Tab.6.c

6.4 Input Register

Index	Size	Ref.	Type	Min/Max	R/W	UoM	Description
0	2	HuP2	INT		R	h	HuP2 - User pump 2 working hours
2	2	HuP2	INT		R	h	HuP2 - User pump 2 working hours
4	2	H1C1	INT		R	h	H1C1 - Compr.1 circ.1 working hour
6	2	H1C2	INT		R	h	H1C2 - Compr.2 circ.1 working hour
8	2	H2C1	INT		R	h	H2C1 - Compr.1 circ.2 working hour
10	2	H2C2	INT		R	h	H2C2 - Compr.2 circ.2 working hour
12	2	dSt1	REAL		R	°C/°F	dSt1 - Discharge temp. probe of circ.1
14	2	Sct1	REAL		R	°C/°F	Sct1 - Suction temp. of circ.1
16	2	dSt2	REAL		R	°C/°F	dSt2 - Discharge temp. probe of circ.2
18	2	Sct2	REAL		R	°C/°F	Sct2 - Suction temp. of circ.2
20	2	dSP1	REAL		R	bar/psi	dSP1 - Discharge press. probe of circ.1
22	2	ScP1	REAL		R	bar/psi	ScP1 - Suction press. of circ.1
24	2	Cnd1	REAL		R	°C/°F	Cnd1 - Cond. temp. probe (or press. probe converted value) of circ.1
26	2	EuP1	REAL		R	°C/°F	EuP1 - Evap. temp. probe (or press. probe converted value) of circ.1
28	2	dSP2	REAL		R	bar/psi	dSP2 - Discharge press. probe of circ.2
30	2	ScP2	REAL		R	bar/psi	ScP2 - Suction press. of circ.2
32	2	Cnd2	REAL		R	°C/°F	Cnd2 - Cond. temp. probe (or press. probe converted value) of circ.2
34	2	EuP2	REAL		R	°C/°F	EuP2 - Evap. temp. probe (or press. probe converted value) of circ.2
36	2	HSP1	INT		R	h	HSP1 - Source pump 1 working hours
38	1	C045	INT		R	-	C045 - Refrigerant type 3=R407C, 4=R410a, 6=R290, 10=R744, 22=R32
40	2	HFn1	INT		R	h	HFn1 - Source fan 1 circ.1 working hour
42	2	HFn2	INT		R	h	HFn2 - Source fan 1 circ.2 working hour
44	2	SPrb	REAL		R	°C/°F	SPrb - Return temp. Water/Air from source

Index	Size	Ref.	Type	Min/Max	R/W	UoM	Description
46	2	SEtA	REAL		R	°C/°F	SEtA - Actual setpoint used by thermoregulation
48	2	SSH1	REAL		R	K/R	SSH1 - Suction Superheat of circ.1
50	1	Opn1	INT		R	%	Opn1 - EEV position of circ.1
51	2	SSH2	REAL		R	K/R	SSH2 - Suction Superheat of circ.2
53	1	Opn2	INT		R	%	Opn2 - EEV position of circ.2
54	2	rUSr	REAL		R	°C/°F	rUSr - Return water temp. from user
56	2	dUSr	REAL		R	°C/°F	dUSr - Delivery water temperature to user
65	2		REAL		R	%	Fan1Req - Inverter request source fan circ.1
67	2		REAL		R	%	Fan2Req - Inverter request source fan circ.2
71	1		INT		R		Unit status (0=OFF by remote DI, 1=OFF by keyboard, 2=OFF by scheduler, 3=OFF by BMS, 4=OFF by changeover mode Ch/HP, 5=OFF by alarm, 6=Unit in defrosting, 7=Unit ON)
90	2	rSPt	REAL		R	°C/°F	rSPt - Remote set point (from analog input)
92	2		REAL		R	%	PwrReq - Power request
94	2		REAL		R	%	FC_PrwReq - Free-Cooling regulation ramp
96	2		REAL		R	°C/°F	SrcSetP_Circ1 - Source fan circ.1 set point
98	2		REAL		R	°C/°F	SrcSetP_Circ2 - Source fan circ.2 set point
100	2	rps	REAL		R	rps	Actual rotor speed coming from inverter
102	2	Mc	REAL		R	A	Mc - Current motor current [A]
104	2	MP	REAL		R	kW	MP - Current motor consumption [kW]
106	2	Drt	REAL		R	°C/°F	Drt - Current drive temperature[°C]
108	1	AIHs1	UINT		R		AIHs1 - Records the last alarm (the more recent)
109	1	AIHs2	UINT		R		AIHs2 - Records the last-but-1st alarm
110	1	AIHs3	UINT		R		AIHs3 - Records the last-but-2nd alarm
111	1	AIHs4	UINT		R		AIHs4 - Records the last-but-3rd alarm

Tab.6.d

7. Alarms and signals

7.1 Types of alarms

The controller manages three types of alarms, depending on the reset mode:

- A - automatic: the alarm is reset and the device restarts automatically when the alarm condition is no longer present;
- R - semi-automatic: if the alarm occurs several times, reset becomes manual and an operator needs to physically restart the device.
- M - manual: an operator an operator needs to physically restart the device.

Alarms that require technical service are shown on the display with the flashing spanner icon.

If the spanner icon is on, it means that a device has reached the programmed operating hour threshold, and maintenance is required (the alarm code indicates which device is affected).

7.1.1 Active alarms

➔ **Note:** the user terminal can only access the active alarms without password protection, or, with password protection, to the alarms relating to unit initialisation and optimisation.

Active alarms are signalled by buzzer and the Alarm button lighting up. Pressing Alarm mutes the buzzer and displays the alarm code (on the top row) and any additional information (on the bottom row). Alarm activation is recorded in the alarm log.

If the alarm is reset automatically, the Alarm button goes off, the alarm code is cleared from the list and the alarm reset event is recorded in the alarm log.

Procedure (alarm acknowledgement):

1. press Alarm: the buzzer is muted, the alarm code is shown on the display;
2. press UP/DOWN to scroll through the list of alarms;
3. when finished, press Esc and then PRG to exit.

Procedure:



When an alarm is active, the buzzer sounds and the Alarm button lights up



Pressing Alarm mutes the buzzer and displays the alarm code; pressing UP/DOWN scrolls the list of any other alarms.



When reaching the end of the alarm list, "ESC" is shown: press PRG to exit the alarm list.



Pressing the Alarm button for more than 3 s resets the alarms: noAL indicates that there are no more active alarms. Press PRG to exit the alarm list.

A single alarm can be reset by pressing Alarm for more than 3 s. If the condition that generated the alarm is still present, the alarm will be reactivated. The alarm log can be deleted using parameter ClrH, accessible via the Service level on the terminal or APPLICA via smartphone, with BLE connection, using the specific function on the alarm page ("Service" level access). The same operations can be performed with APPLICA via smartphone, using the specific function on the alarm page (a BLE connection and "Service" level access are required).

➔ **Note:**

- deletion of the alarm log is irreversible;
- See chapter "Functions" for the alarm parameters: evaporator outlet temperature, frost protection, compressor.

7.2 Alarm list

Code	Description	Reset	Effect	Buzzer	LED	Priority	Delay	No. of attempts	Evaluation period (s)
A01	Unit: no. of permanent memory writes	M	-	X	X	Fault	No	-	-
A02	Unit: permanent memory writes	M	-	-	X	Fault	No	-	-
A03	Unit: remote alarm from digital input	M	Unit shutdown	X	X	Serious, unit	No	-	-
A04	Unit: remote set point probe	A	Use standard set point	X	X	Fault	10s	-	-
A05	Unit: user return water temperature probe	A	Unit shutdown	-	X	Serious, unit	10s	-	-
A06	Unit: user delivery water temperature probe	A	Unit shutdown	- / X	X	Serious, unit	10s	-	-
A08	Unit: user pump 1 overload	M	-	-	X	Fault	No	-	-
A09	Unit: user pump 2 overload	M	-	X	X	Fault	No	-	-
A10	Unit: flow switch (with user pump 1 active)	M	Unit shutdown	X	X	Serious, unit	Par. U046/U047	-	-
A11	Unit: flow switch (with user pump 2 active)	M	Unit shutdown	-	X	Serious, unit	Par. U046/U047	-	-
A12	Unit: user pump group	M	Unit shutdown	- / X	X	Serious, unit	No	-	-
A13	Unit: user pump 1 maintenance	A	-	-	-	Fault	Par. U000	-	-
A14	Unit: user pump 2 maintenance	A	-	-	-	Fault	Par. U003	-	-
A15	Unit: high chilled water temperature	A	-	X	X	Fault	Par. U033/U034	-	-
A16	Unit: source return water/air temperature probe	A	Disable FC and Compensation (A/W units)	X	X	Fault	10s	-	-
A17	Unit: source pump 1 maintenance	A	-	-	-	Fault	Par. S000	-	-
A18	Unit: free cooling warning	M	Disable FC	X	X	Fault	Par. U033/180s	-	-
A19	Circuit 1: discharge pressure probe	A	Circuit 1 shutdown	X	X	Serious, circuit 1	10s	-	-
A20	Circuit 1: condensing temperature probe	A	Circuit 1 shutdown	X	X	Serious, circuit 1	10s	-	-
A21	Circuit 1: suction pressure probe	A	Circuit 1 shutdown	X	X	Serious, circuit 1	10s	-	-
A22	Circuit 1: evaporation temperature probe	A	Circuit 1 shutdown	X	X	Serious, circuit 1	10s	-	-
A23	Circuit 1: discharge temperature probe	A	Circuit 1 shutdown	X	X	Serious, circuit 1	10s	-	-
A24	Circuit 1: suction temperature probe	A	Circuit 1 shutdown	X	X	Serious, circuit 1	10s	-	-
A25	Circuit 1: high pressure switch	M	Circuit 1 shutdown	X	X	Serious, circuit 1	No	-	-
A26	Circuit 1: high pressure transducer	M	Circuit 1 shutdown	X	X	Serious, circuit 1	Par. C017	-	-
A27	Circuit 1: low pressure transducer	A (R)	Circuit 1 shutdown	X	X	Serious, circuit 1	Par. C018	3	3600
A28	Circuit 1: frost protection evaporation temperature	M	Circuit 1 shutdown	X	X	Serious, circuit 1	Par. U053	-	-
A30	Circuit 1: compressor 1 overload	M	Comp. 1 circ. 1 shutdown	X	X	Fault, circuit 1	No	3	3600
A31	Circuit 1: compressor 2 overload	M	Comp. 2 circ. 1 shutdown	X	X	Fault, circuit 1	No	-	-
A32	Circuit 1: compressor 1 maintenance	A	-	- / X	- / X	Fault, circuit 1	Par. C000	-	-
A33	Circuit 1: compressor 2 maintenance	A	-	-	-	Fault, circuit 1	Par. C003	-	-
A34	Circuit 1: source fan maintenance	A	-	-	-	Fault, circuit 1	Par. S008	-	-
A35	EVD circuit 1: LowSH	M	Circuit 1 shutdown	X	X	Serious, circuit 1	Par. E024	-	-
A36	EVD circuit 1: LOP	A	-	X	X	Fault, circuit 1	Par. E025	3	3600

Code	Description	Reset	Effect	Buzzer	LED	Priority	Delay	No. of attempts	Evaluation period (s)
A37	EVD circuit 1: MOP	A	Circuit 1 shutdown	X	X	Serious, circuit 1	Par. E026	-	-
A38	EVD circuit 1: motor error	M	Circuit 1 shutdown	X	X	Serious, circuit 1	No	-	-
A39	EVD circuit 1: emergency closing	A	-	X	X	Fault, circuit 1	No	-	-
A40	EVD circuit 1: incomplete valve closing	A	-	X	X	Fault, circuit 1	No	-	-
A41	EVD circuit 1: offline	A	Circuit 1 & 2 shutdown	-	X	Serious, circuits 1 & 2	No	-	-
A42	Circuit 1: envelope alarm + zone alarm	A (R)	Circuit 1 shutdown	- / X	X	Serious, circuit 1	Par. Cb17	3	3600
A43	BLDC circuit 1: high pressure differential at start-up	A	BLDC 1 not enabled to start	X	X	Serious, circuit 1	5min	-	-
A44	BLDC circuit 1: failed start-up	A (R)	-	- / X	- / X	Serious, circuit 1	45s	5	3600
A45	BLDC circuit 1: low pressure differential	A	Circuit 1 shutdown	X	X	Serious, circuit 1		-	-
A46	BLDC circuit 1: high gas discharge temp.	M	Circuit 1 shutdown	X	X	Serious, circuit 1		-	-
A47	Speed drive 1: offline	A	Circuit 1 / BLDC 1 shutdown	-	X	Serious, circuit 1	30s	-	-
A48	Speed drive 1: alarm + error code	A	Circuit 1 / BLDC 1 shutdown	- / X	X	Serious, circuit 1	No	3	3600
A49	Unit: slave offline	A	-	X	X	Serious, circuit 2	No	-	-
A50	Slave unit: no. permanent memory writes	M	-	-	X	Fault	No	-	-
A51	Slave unit: permanent memory writes	M	-	X	X	Fault	No	-	-
A52	Circuit 2: discharge pressure probe	A	Circuit 2 shutdown	X	X	Serious, circuit 2	10s	-	-
A53	Circuit 2: condensing temperature probe	A	Circuit 2 shutdown	-	X	Serious, circuit 2	10s	-	-
A54	Circuit 2: suction pressure probe	A	Circuit 2 shutdown	- / X	X	Serious, circuit 2	10s	3	3600
A55	Circuit 2: evaporation temperature probe	A	Circuit 2 shutdown	X	X	Serious, circuit 2	10s	-	-
A56	Circuit 2: discharge temperature probe	A	Circuit 2 shutdown	-	X	Serious, circuit 2	10s	-	-
A57	Circuit 2: suction temperature probe	A	Circuit 2 shutdown	X	X	Serious, circuit 2	10s	-	-
A58	Circuit 2: high pressure switch	M	Circuit 2 shutdown	X	X	Serious, circuit 2	No	-	-
A59	Circuit 2: high pressure transducer	M	Circuit 2 shutdown	-	X	Serious, circuit 2	Par. Cb17	-	-
A60	Circuit 2: low pressure transducer	A (R)	Circuit 2 shutdown	- / X	X	Serious, circuit 2		3	3600
A61	Circuit 2: frost protection evaporation temperature	M	Circuit 2 shutdown	X	X	Serious, circuit 2	Par. A041	-	-
A63	Circuit 2: compressor 1 overload	M	Comp. 1 circ. 2 shutdown	X	X	Fault, circuit 2	No	-	-
A64	Circuit 2: compressor 2 overload	M	Comp. 2 circ. 2 shutdown	X	X	Fault, circuit 2	No	-	-
A65	Circuit 2: compressor 1 maintenance	A	-	-	-	Fault	Par. Ca00	-	-
A66	Circuit 2: compressor 2 maintenance	rr	-	-	-	Fault	Par. Ca02	3	3600
A67	Circuit 2: source fan maintenance	A	-	-	-	Fault	Par. E006	-	-
A68	EVD circuit 2: LowSH	M	Circuit 2 shutdown	-	X	Serious, circuit 2	Par. B024	-	-
A69	EVD circuit 2: LOP	A	Circuit 2 shutdown	X	X	Serious, circuit 2	Par. B025	-	-
A70	EVD circuit 2: MOP	A	Circuit 2 shutdown	X	X	Serious, circuit 2	Par. B026	-	-

Code	Description	Reset	Effect	Buzzer	LED	Priority	Delay	No. of attempts	Evaluation period (s)
						2			
A71	EVD circuit 2: motor error	M	Circuit 2 shutdown	-	X	Serious, circuit 2	No	-	-
A72	EVD circuit 2: emergency closing	A	Circuit 2 shutdown	- / X	X	Serious, circuit 2	No	3	3600
A73	EVD circuit 2: incomplete valve closing	A	Circuit 2 shutdown	X	X	Serious, circuit 2	No	-	-
A74	EVD circuit 2: offline	A	Circuit 2 shutdown	-	X	Serious, circuit 2	No	-	-
A75	Circuit 2: envelope alarm + zone alarm	A	Circuit 2 shutdown	X	X	Serious, circuit 2	Par. Cb17	-	-
A76	BLDC circuit 2: high pressure differential at start-up	A	BLDC 2 not enabled to start	X	X	Serious, circuit 2	5min	-	-
A77	BLDC circuit 2: failed start-up	R	-	-	X	Serious, circuit 2	45	-	-
A78	BLDC circuit 2: low pressure differential	A	Circuit 2 shutdown	- / X	X	Serious, circuit 2		3	3600
A79	BLDC circuit 2: high gas discharge temp.	M	Circuit 2 shutdown	X	X	Serious, circuit 2		-	-
A80	Speeddrive circuit 2: offline	A	Circuit 2 / BLDC 2 shutdown	-	X	Serious, circuit 2	30s	-	-
A81	Speed drive circuit 2: alarm + error code	A	Circuit 2 / BLDC 2 shutdown	X	X	Serious, circuit 2	No	-	-

8. Technical specifications

Model	UCHBP* (panel models)	UCHBD* (DIN rail models)
Physical specifications		
Dimensions	See figures	
Case	Polycarbonate	
Mounting	panel	DIN rail
Ball pressure test temperature	125°C	
Ingress protection	IP20 (rear) - IP65 (front)	IP00
Front cleaning	Use soft, non-abrasive cloth and neutral detergent or water	-
Environmental conditions		
Storage conditions	-40T85°C, <90 % RH non-condensing	
Operating conditions	-20T60°C, <90 % RH non-condensing	
Electrical characteristics		
Rated power supply	SELV or PELV power supply, Class 2	
Operating power supply voltage	24 Vac/dc, +10% -15%	
Input frequency	50/60 Hz	
Maximum current draw	600 mA rms	
Min. power consumption	400 mW	
Clock	precision: ± 50 ppm; min time maintenance after power off: 72 h	
Software class and structure	A	
Pollution degree	3	
Class of protection against electric shock	To be incorporated in class I or II appliances	
Type of action and disconnection	1.C	
Rated impulse voltage	relay outputs: 4 kV; 24 V input: 0.5 kV	
Surge immunity category	relay outputs: 3; input 24: 2	
Control device construction	Device to be incorporated	
Terminal block	Plug-in male-female. Wire sizes: see the connector table	
Purpose of the controller	Electrical operating control	
User interface		
Buzzer	built-in	not included on the controller, built into the user terminal
Display	LED 2 rows, decimal point, and multi-function icons	
Connectivity		
NFC	Max distance 10mm, variable according to the mobile device used	
Bluetooth Low Energy	Max distance 10m, variable according to the mobile device used	
BMS serial interface	Modbus over RS485, not opto-isolated	
FieldBUS serial interface	Modbus over RS485, not opto-isolated	
HMI interface	Modbus over RS485, not opto-isolated	
Analogue inputs (Lmax=10m)		
J2	S1, S2, S3: NTC	NTC: resolution 0.1 °C; 10Kohm @ 25 °C, error: $\pm 1^\circ\text{C}$ in the range -50T50°C, $\pm 3^\circ\text{C}$ in the range 50T90°C; 0-5 V ratiometric: error 2% fs, typical 1%; 4-20 mA: error 5% fs, typical 1%; 0-10 V: error 2% fs, typical 1%
	S5: 0-5V ratiometric / 4-20 mA / NTC	
J3	S4: 0-5 V ratiometric / 4-20 mA / NTC	
	S6: 0-5 V ratiometric / 0-10V / 4-20 mA / NTC	
J9	S7: NTC (DIN version only)	NTC: resolution 0.1 °C; 10Kohm @ 25 °C, error: $\pm 1^\circ\text{C}$ in the range -50T50°C, $\pm 3^\circ\text{C}$ in the range 50T90°C;
Digital inputs (Lmax=10m)		
J2	ID1(*)	Voltage-free contact, not optically-isolated, typical closing current 6 mA, voltage with contact open 13 V, max contact resistance 50 Ω (* Fast digital input: 0-2 kHz; error 2% fs
J2	ID2	
J3	ID3(*), ID4, ID5,	
J9	ID6 - avail. only on DIN vers.	

Model	UCHBP* (panel models)	UCHBD* (DIN rail models)
Valve output		
J14	Available only on DIN version	CAREL E*V unipolar valve power supply: 13 Vdc, min winding resistance 40 Ω
Analogue outputs (Lmax=10m)		
J14	Y1, Y2	0-10 Vdc: 10 mA max
Digital outputs (Lmax=10m)		
NOTE: the sum of current draw on NO1, NO2, NO3 and NO4 must not exceed 8 A		
J6	NO1(5A), NO2(5A), NO3(5A), NO4(5A); NO5; J11: NO6 (only on DIN mod.)	5A: EN60730: 5 A resistive, 250 Vac, 50k cycles; 4(1), 230 Vac, 100k cycles; 3 (1), 230 Vac, 100k cycles
J7	NO5 (5A); J11: NO6 (only on DIN mod.)	UL60730: 5 A resistive, 250 Vac, 30k cycles; 1 FLA, 6 LRA, 250 Vac, 30k cycles; Pilot Duty C300, 30k cycles
J11	NO6 (5A) - only on DIN mod.)	
Emergency power supply		
J10: Ultracap module (optional, available only on DIN version)	-	13 Vdc ±10%
Probe and terminal power supply (Lmax=10m)		
5 V		5 Vdc ± 2% to power the 0 to 5 V ratiometric probes. Maximum current delivered: 10 mA protected against short-circuit
+V		8-11 V to power the 4-20 mA current probes. Maximum current delivered: 25 mA protected against short-circuits
VL		Not used
J8		User terminal power supply
Serial ports		
BMS	Lmax=500 m, shielded cable (RS485 1½ twisted pair) (1)	<ul style="list-style-type: none"> • Integrated • Protocol: Modbus • HW driver: asynchronous half duplex RS 485 Slave • Not optically-isolated • 3-pin plug-in connector, 3.81 mm pitch • Max data rate: 115200 bit/s • Maximum number of connectable devices: 16
FieldBus	J5: Lmax=10 m, shielded cable (RS485 1½ twisted pair) (1)	<ul style="list-style-type: none"> • Integrated • HW driver: asynchronous half duplex RS 485 Master. Typical reception resistance 96 kohms, equal to 1/8 of unit load, i.e. 1/256 of maximum load applicable on the line • Not optically-isolated • Max data rate: 19200 bit/s • Maximum number of connectable devices: 16 • Protocol: Modbus RTU
Cable lengths		
Analogue inputs/outputs, digital inputs/outputs, probe power		<10 m (*) (**) (*) in the panel version, if using the +13 V power supply in domestic environments, the maximum cable length is 2 m. (**) in the DIN version powered at 115 Vac, if using +VDC in domestic environments, the maximum cable length is 2 m.
Valve		< 2 m, < 6 m with shielded cable
BMS and Fieldbus serial cables		<500m with shielded cable
Conformity		
Electrical safety		EN/UL 60730-1, EN/UL 60335-1
Electromagnetic compatibility		EN 61000-6-1, EN 61000-6-2, EN 61000-6-3, EN 61000-6-4
Applications with flammable refrigerant gases		EN/UL 60079-15, EN/UL 60335-2-34, EN/UL 60335-2-40, EN/UL 60335-2-89
Wireless compliance		RED, FCC, IC

 **Note:** (1) it is recommended to use a BELDEN 8761 cable (AWG 22).

8.1 Connector/cable table

Ref.	Description	Wiring terminals	Wire cross-section (mm ²)	Lmax (m)
J1	Controller power supply	Panel model: plug-in terminal, screw, 2-pin, pitch 5.08	0.5-1.5	10
		DIN rail model: plug-in terminal, screw, 2-pin, pitch 5.08	0.21-3.31	10
J2	Inputs S1, S2, S3, S5, ID1, ID2; outputs Y2, Y2	10-pin Microfit crimp connector	0.05-0.52	10
J3	Inputs S4, S6, ID3, ID4, ID5	8-pin Microfit crimp connector	0.05-0.52	10
J4	BMS	Plug-in screw terminal, 3-pin, pitch 3.81	0.081-1.31	500
J5	Fbus	Plug-in screw terminal, 3-pin, pitch 3.81	0.081-1.31	10
J6	Outputs NO1, NO2, NO3, NO4	6-pin Microfit crimp connector	0.5-1.31	10
J7	Output NO5	3-pin Microfit crimp connector	0.5-1.31	10
J8	HMI remote terminal	Connection cable P/N: ACS00CB000010 (L=3m)-/20 (L=1.5m)	0.13	2
J9	Inputs S7, ID6	4-pin Microfit crimp connector	0.05-0.52	10
J10	Ultracap	3-pin JST connector	0.13	2
J11	Output NO6	3-pin Microfit crimp connector	0.5-1.31	10
J14	Unipolar ExV valve	CAREL ExV unipolar valve connector, pre-wired	-	2, 6 with shielded cable

Tab.8.a

9. Release notes

Software version - date	Manual version - date	Release
1.1.9; 08/03/2018	1.0; 16/03/2018	First
1.1.15 (On-Off compressor); 11-09-2018	1.1; 11-09-2018	Second
1.0.3 (BLDC compressor); 12-09-2018		

Tab.9a

CAREL

CAREL INDUSTRIES S.p.A. - Headquarters

Via dell'Industria, 11

35020 Brugine - Padova (Italy)

Tel. (+39) 049.9716611

Fax (+39) 049.9716600

email: carel@carel.com - www.carel.com

CAREL can accept no responsibility for possible errors in this manual.
CAREL reserves the right to modify its products without notice.