

2020

Fiyat Listesi



EMERSONTM

CopelandTM
brand products

Copeland ScrollTM

Alco ControlsTM

CAREL
— — — — —

VILTERTM
Since 1867

**ER
U
E**



ACR İKLİMLENDİRME

AUTOMATION - AIR CONDITIONING - REFRIGERATION

ACR İKLİMLENDİRME SOĞUTMA VE OTOMASYON SAN.TİC.A.Ş.

1082 Sok No:3Y Halkapınar Mah. KONAK / İZMİR

Ege Vergi Dairesi 0051196092

Tel : +90 232 433 3 227

Tel : +90 232 433 4 227

Tel : +90 232 433 5 227

Fax : +90 232 433 6 227

e-mail : info@acriklimlendirme.com

www.acriklimlendirme.com

Banka Adı	ŞUBE	HESAP TÜRÜ	IBAN NO
Garanti BBVA	GARANTİ BANKASI TOPTANCILAR ÇARŞISI	TL	TR97 0006 2000 2690 0006 2926 39
YapıKredi	YAPI KREDİ BANKASI MANAVKUYU ŞB.	TL	TR58 0006 7010 0000 0069 7817 27
HALKBANK	HALKBANK YENİ SANAYİ ŞB.	TL	TR75 0001 2009 7080 0010 2613 09

Garanti BBVA	GARANTİ BANKASI TOPTANCILAR ÇARŞISI	EURO	TR63 0006 2000 2690 0009 0856 87
YapıKredi	YAPI KREDİ BANKASI MANAVKUYU ŞB.	EURO	TR04 0006 7010 0000 0073 8492 30
HALKBANK	HALKBANK YENİ SANAYİ ŞB.	EURO	TR76 0001 2009 7080 0058 0004 23

Garanti BBVA	GARANTİ BANKASI TOPTANCILAR ÇARŞISI	USD	TR90 0006 2000 2690 0009 0856 86
YapıKredi	YAPI KREDİ BANKASI MANAVKUYU ŞB.	USD	TR10 0006 7010 0000 0073 9547 55
HALKBANK	HALKBANK YENİ SANAYİ ŞB.	USD	TR11 0001 2009 7080 0053 0007 58

* Fiyatlarımızda KDV Hariçtir.

* Şirketimiz, önceden haber vermeksizin fiyatları değiştirme hakkına sahiptir.

* Döviz kuru, yukarıda çalıştığımız bankaların döviz satış kuru üzerinden hesaplanır.

CAREL PARAMETRİK CHILLER KONTROL CİHAZLARI

CAREL

Hava / Su ve SU / Su soğutucuları ve Isı pompaları yönetimi.
2 On/Off Komp veya 1 Bldc Komp. + 1 On/Off
Mobil cihazlarla kablosuz bağlantı. (Android NFC)

•Barkodu okutarak ürün kullanım kılavuzuna ulaşabilirsiniz.



MODEL	AÇIKLAMA			FİYAT	
UCHBP00000090	1 DEVRE 2 KOMPRESÖR	NFC	PANEL	Bipolar EVD Driver	213 €
UCHBP00000100	1 DEVRE 2 KOMPRESÖR	NFC Bluetooth	PANEL	Bipolar EVD Driver	279 €
UCHBD00001130	1 DEVRE 2 KOMPRESÖR	-	RAY	Bipolar EVD Driver	195 €
UCHBDE0001140		-	RAY	Bipolar EVD Driver Harici EVD Driver bağlanabilir.	251 €
UCHBDH0001150	1 DEVRE 2 KOMPRESÖR +BLDC	-	RAY	Bipolar EVD Driver Harici EVD Driver bağlanabilir.	306 €
UCHBE00001130	2 DEVRE 2 KOMPRESÖR İlave genişlem kartı ile	-	RAY	Harici EVD Driver bağlanabilir.	184 €
UCHBE00001140	2 DEVRE 2 KOMPRESÖR İlave genişlem kartı ile	Geliştirilmiş versiyon	RAY	Harici EVD Driver bağlanabilir.	251 €
AX5000PD20A20	Ekran (Panel Montaj)	NFC		106 €	
AX5000PD20A30	Ekran (Panel Montaj)	NFC Bluetooth		139 €	
PGR04000TBDA0	PGDX 4,3" Garafik Dokunmatik Ekran IP65, RS485 Panel montaj		275 €		
PGR04000WCA00	PGDX 4,3" Garafik Dokunmatik Ekran IP65, RS485 Duvar montaj		374 €		
PGR04000TABA0	PGDX 4,3" Garafik Dokunmatik Ekran RJ12 Panel montaj		277 €		
PGTA00FB00	PGDX 4,3" Garafik Dokunmatik Ekran için siyah çerçeve		14 €		
ACS00CB000020	Ekran Bağlantı Kablosu L=1,5mt		9 €		
ACS00CB000010	Ekran Bağlantı Kablosu L=3mt		12 €		

CAREL PARAMETRİK

Standart Kompresör kademe kontrol
Tek veya İki devre (Piston / scroll)

4 adede kadar kompresör kontrolü
Değişik veya aynı kapasitelerde kompresör yönetimi
iki devre orta veya alçak basınç sistem kontrolü
Kompresör veya fan kontrolü
PWM Kondenser fan çıkışı
Ölü bant kontrolü

•Barkodu okutarak ürün kullanım kılavuzuna ulaşabilirsiniz.



MODEL	AÇIKLAMA	FİYAT
MRK00070DK	MRACK DIN KIT MRK00000D0+SPKT0013P0+SPKT0033P0+SPKC002310(2PCS.)+MCHSMLCAB2	348 €
MCH2004850	RS485 MODUL	69 €

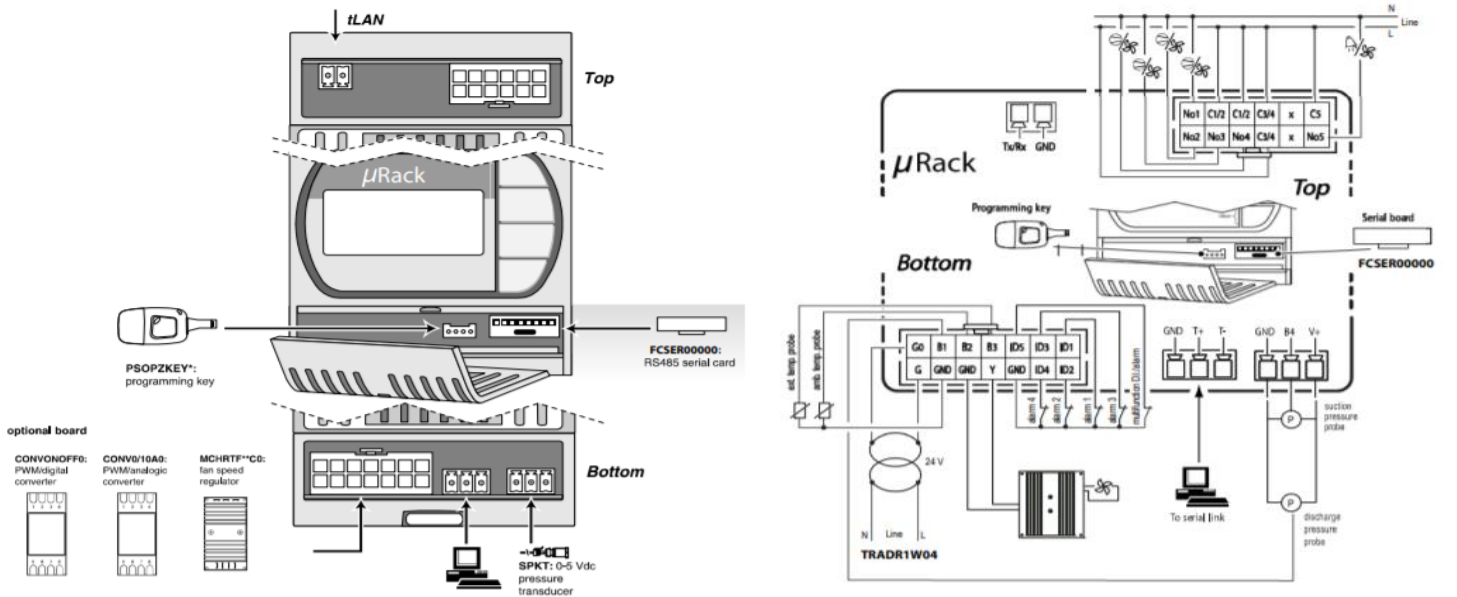

CAREL PARAMETRİK Standart

Kompresör Kademe Kontrol

Büyük ölçekli sistemler

(Scroll, pistonlu, dijital scroll, vidalı kompresör)

CAREL



2 Emiş hattı ve 2 kondenser hattı
Scroll, piston, dijital scroll, vidalı kompresör yönetimi
Devre başına 12 adede kadar scroll veya pistonlu kompresör kontrolü (Maks. 4 farklı kompresör boyutu)
Devre başına 2 adet vidalı kompresör maksimum tek devre
Bitzer CRII Kompresör kontrolü maksimum tek devre
Devre başına 16 adede kadar fan kontrolü
İnverterli kompresör yönetimi
Fan kontrolü için inverter çıkışı
Isı geri kazanım



•Barkodu okutarak ürün kullanım kılavuzuna ulaşabilirsiniz.

MODEL	KOD	AÇIKLAMA				FİYAT	
		AI	DI	AO	DO		
Small	PRK300S3F0	8	8	4	8	Usb, Ekranlı, Bms/Fbus + Klemens	832,93 €
Medium	PRK300M3F0	8	14	4	13	Usb, Ekranlı, Bms/Fbus + Klemens	1.029,01 €
Large	PRK300L3F0	10	18	6	18	Usb, Ekranlı, Bms/Fbus + Klemens	1.158,17 €

TİP	DEVRE	Kompresör				Kondenser Fan		pR300
		Tip	Adet	Kapasite	Kontrol	Adet	Çalışma Tipi	
RS2	1	Piston - Scroll	2	-	-	2	-	Small
RS3	1	Piston - Scroll	3	-	-	3	-	Small
RS3p	1	Piston - Scroll	3	1	-	1	İnverter	Medium
RS3İ	1	Piston - Scroll	3	-	İnv.	1	İnverter	Medium
RS4	1	Piston - Scroll	4	-	-	4	-	Medium
RS4i	1	Piston - Scroll	4	-	İnv.	1	İnverter	Large
SL3d	1	Scroll	3	-	Digital	2	-	Medium
SL5d	1	Scroll	5	-	Digital	1	İnverter	Small
SW1	1	Vidalı	1	2	-	2	-	Small
SW2	1	Vidalı	2	2	-	1	İnverter	Small
d-RS2	2	Piston - Scroll	2	-	-	2	-	Medium
d-RS3	2	Piston - Scroll	3	-	-	3	-	Large
d-RS4	2	Piston - Scroll	4	-	İnv.	1	İnverter	Medium + Medium
			4	-	İnv.	1	İnverter	

CAREL PARAMETRİK

Kompresör kademe kontrol
(Scroll, Pistonlu, Dijital scroll, Vidalı kompresör)

CAREL

pRack PR300 S, M, L, MD



Small

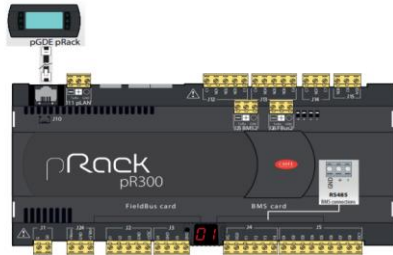

Medium

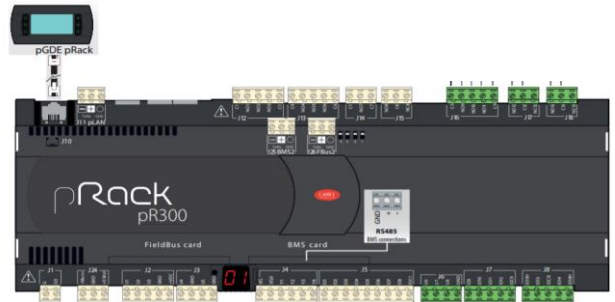

Large

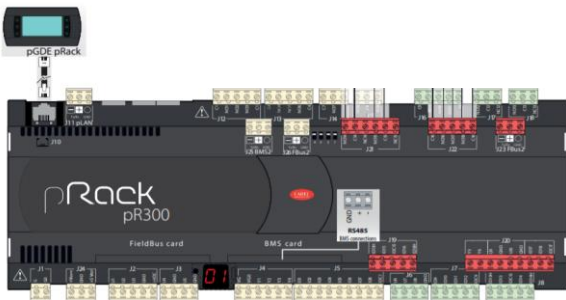

Built-in Driver

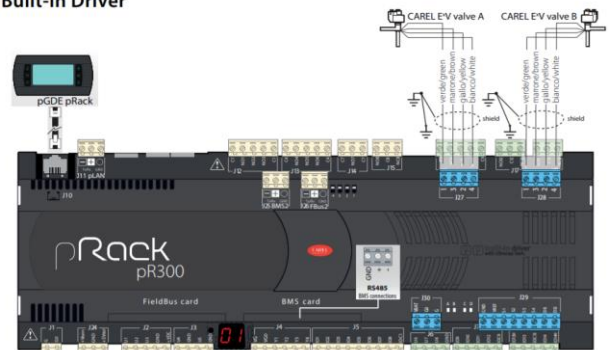





CAREL Fan Hız Kontrol Cihazları

CAREL



Faz kesme prensibine göre çıkış voltajını düzenler.
Asenkron elektrik motorlarını kontrol etmek için kullanılır.
Soğutma / Isıtma kontrolü, minimum ve maksimum Hız, kesme, hızlanma,
defrost
pCO serisi 0-10V μ C2 (PWM, darbe genişlik modülasyonu)





MODEL	ANMA AKIMI	AÇIKLAMA	KONTROL SİNYAL TİPİ	FİYAT
MCHRTF04C0	4A	230Vac (-15% - +10%) 50/60Hz 	PWM (IP00) Barkodu okutarak ürün kullanım kılavuzuna ulaşabilirsiniz.	40,46 €
MCHRTF08C0	8A			66,21 €
MCHRTF12C0	12A			84,61 €

MODEL	ANMA AKIMI	AÇIKLAMA	KONTROL SİNYAL TİPİ	FİYAT
FCSM0423L0	4A	230Vac (-15% - +10%) 50/60Hz 	0-10Vdc (IP00) Barkodu okutarak ürün kullanım kılavuzuna ulaşabilirsiniz.	82,93 €
FCSM0823L0	8A			81,39 €
FCSM1223L0	12A			95,98 €

MODEL	ANMA AKIMI	AÇIKLAMA	FİYAT
FCPM00A01K	8A	Transmitter + Kablo + Hız kontrol 	177,80 €

MODEL	ANMA AKIMI	AÇIKLAMA	KONTROL SİNYAL TİPİ	FİYAT
FCS3204000	20A	400Vac (-15% - +10%) 50/60Hz 	 Barkodu okutarak ürün kullanım kılavuzuna ulaşabilirsiniz.	518,29 €
FCS3404000	40A			907,86 €

MODEL	ANMA AKIMI	AÇIKLAMA	KONTROL SİNYAL TİPİ	FİYAT
FCS3094010	9A	400Vac (-15% - +10%) 50/60Hz 	0-10Vdc / PWM (IP20)  Barkodu okutarak ürün kullanım kılavuzuna ulaşabilirsiniz.	437,64 €
FCS3124010	12A			488,75 €
FCS3204010	20A			641,46 €
FCS3404010	40A			1.091,25 €

CAREL Santrifuj Nemlendirici

CAREL

Suyu merkezkaç kuvveti ile atomize etme prensibine göre çalışır.
Cihaz içme suyu veya demineralize su ile çalışabilir.
HumiDisk10, 1 kg / saat atomize buhar üretmektedir.
HumiDisk65 ile 6,5 kg / saat atomize buhar üretimi.



MODEL	AÇIKLAMA	FİYAT
UC0100D000	1,0 kg/h -230v 50Hz	617,14 €
UC0650D000	6,5 kg/h -230v 50Hz	811,05 €

MODEL	AÇIKLAMA	FİYAT
ASPC110000	Endüstriyel Nem probu 10%-90% + sıcaklık	117,09 €
IR33V9HR20	2 UNIVERSAL INPUTS, 1DO, BUZ, IR, 115-230VAC HİGROSTAT	121,22 €

Nemlendirme Cihazlarında Higrostat ve Nem Sensörü Fiyata Dahil Değildir.

Carel nemlendiriciler; soğuk odalar, depolar, seralar, filizlenme odaları ile hassas nemlendirme istenen uygulamalar için tasarlanmıştır. Çok küçük bir su tankına sahip olan cihaz hijyen için otomatik olarak suyu boşaltarak nemlendirmeye başlamaktadır.



CAREL

CAREL

Daldırma Elektrotlu Nemlendirici

Hasas +/-%1 bağıl nem, tam aralık modülasyonu
Maksimum Hijyen
1,5 ila 45Kg/saat arası modeller
Harici giriş 0-10 V, 2-10 V, 0-1V sinyal ile oransal kontrol
BMS üzerinden uzaktan konfigürasyon (RS485)



•Barkodu okutarak ürün kullanım kılavuzuna ulaşabilirsiniz.



MODEL	AÇIKLAMA			FİYAT
KUESRF KIT	KUESRF0000	CAREL OEM NEMLENDİRİCİ 1.5-3 kg/h	1	919,41 €
	CPY03D02V0	CAREL CONTROL BOARD	1	
	CPYCONN000	CAREL CONNECTOR KITS	1	
	UEKTAM0001	Akım Trafosu	1	
	DP030D30R0	Steam Distributors for ducts/Stainless Steel steam distributor, inlet Ø=30 mm, l=300 mm	1	
	1312368AXX	Condansate drain hose Ø=10 mm (per metre)	2	
	1312365AXX	Steam hose with steel spring Ø= 30 mm (per metre)	2	
KUET2C KIT	KUET2C0000	CAREL OEM NEMLENDİRİCİ 5-8 kg/h	1	937,88 €
	CPY0000200	CAREL CONTROL BOARD	1	
	CPYCONN000	CAREL CONNECTOR KITS	1	
	DP060D30R0	Steam Distributors for ducts/Stainless Steel steam distributor, inlet Ø=30 mm, l=600 mm	1	
	UEKTAM0001	Akım Trafosu	1	
	1312368AXX	Condansate drain hose Ø=10 mm (per metre)	2	
	1312365AXX	Steam hose with steel spring Ø= 30 mm (per metre)	2	
KUET3C KIT	KUET3C0000	CAREL OEM NEMLENDİRİCİ 9-10-15-18 kg/h	1	1.064,00 €
	CPY0000200	CAREL CONTROL BOARD	1	
	CPYCONN000	CAREL CONNECTOR KITS	1	
	DP060D30R0	Steam Distributors for ducts/Stainless Steel steam distributor, inlet Ø=30 mm, l=600 mm	1	
	UEKTAM0001	Akım Trafosu	1	
	1312368AXX	Condansate drain hose Ø=10 mm (per metre)	2	
	1312365AXX	Steam hose with steel spring Ø= 30 mm (per metre)	2	
KUET4C KIT	KUET4C0000	CAREL OEM NEMLENDİRİCİ 25-45 kg/h	1	1.424,04 €
	CPY0000200	CAREL CONTROL BOARD	1	
	CPYCONN000	CAREL CONNECTOR KITS	1	
	DP060D40RU	Steam Distributors for ducts/Stainless Steel steam distributor, inlet Ø=40 mm, l=600 mm	1	
	UEKTAM0001	Akım Trafosu	1	
	1312368AXX	Condansate drain hose Ø=10 mm (per metre)	2	
	1312367AXX	Steam hose with steel spring Ø= 40 mm (per metre)	2	

CAREL

Daldırma Elektrotlu Nemlendirici

Hasas +/-%1 bağıl nem, tam aralık modülasyonu
Maksimum Hijyen
1,5 ila 45Kg/saat arası modeller
Harici giriş 0-10 V, 2-10 V, 0-1V sinyal ile oransal kontrol
BMS üzerinden uzaktan konfigürasyon (RS485)



•Barkodu okutarak ürün kullanım kılavuzuna ulaşabilirsiniz.

CAREL



MODEL	AÇIKLAMA			FİYAT
KUESRF KIT	KUESRF0000	CAREL OEM NEMLENDİRİCİ 1.5-3 kg/h	1	772,46 €
	CPY03D02V0	CAREL CONTROL BOARD	1	
	CPYCONN000	CAREL CONNECTOR KITS	1	
	UEKTAM0001	Akım Trafosu	1	
KUET2C KIT	KUET2C0000	CAREL OEM NEMLENDİRİCİ 5-8 kg/h	1	777,36 €
	CPY0000200	CAREL CONTROL BOARD	1	
	CPYCONN000	CAREL CONNECTOR KITS	1	
	UEKTAM0001	Akım Trafosu	1	
KUET3C KIT	KUET3C0000	CAREL OEM NEMLENDİRİCİ 9-10-15-18 kg/h	1	887,66 €
	CPY0000200	CAREL CONTROL BOARD	1	
	CPYCONN000	CAREL CONNECTOR KITS	1	
	UEKTAM0001	Akım Trafosu	1	
KUET4C KIT	KUET4C0000	CAREL OEM NEMLENDİRİCİ 25-45 kg/h	1	1.175,68 €
	CPY0000200	CAREL CONTROL BOARD	1	
	CPYCONN000	CAREL CONNECTOR KITS	1	
	UEKTAM0001	Akım Trafosu	1	



Aşırı ısınmaya karşı güvenilirlik ve tam koruma
 Hasas +%1 bağıl nem, tam aralık modülasyonu
 Maksimum Hijyen
 2 ila 80Kg/saat arası modeller
 On/OFF ve oransal kontrol imkanı
 Harici giriş 0-10 V, 2-10 V, 0-20 mA, 4-20 mA %20 ile %100 arası kontrol
 BMS üzerinden uzaktan konfigürasyon (RS485)



MODEL	AÇIKLAMA			FİYAT
UE005YLKIT	UE005YL001	400 V 3 Faz Nemlendirici 5 kg/h On/Off veya 0-10V Oransal Kontrol	1ad.	1.092,72 €
	DP030D30R0	Paslanmaz Çelik Distribütör , inlet Ø30mm, l=300mm	1ad.	
	1312368AXX	Yoğuşma tahliye hortumu Ø10mm	2Mt	
	1312365AXX	Çelik yaylı buhar hortumu Ø30mm	2Mt	
UE010YLKIT	UE0010YL001	400 V 3 Faz Nemlendirici 10 kg/h On/Off veya 0-10V Oransal Kontrol	1ad.	1.211,61 €
	DP060D30RU	Paslanmaz Çelik Distribütör , inlet Ø30mm, l=600mm	1ad.	
	1312368AXX	Yoğuşma tahliye hortumu Ø10mm	2Mt	
	1312365AXX	Çelik yaylı buhar hortumu Ø30mm	2Mt	
UE018YLKIT	UE018YL001	400 V 3 Faz Nemlendirici 18 kg/h On/Off veya 0-10V Oransal Kontrol	1ad.	1.285,22 €
	DP060D30RU	Paslanmaz Çelik Distribütör , inlet Ø30mm, l=600mm	1ad.	
	1312368AXX	Yoğuşma tahliye hortumu Ø10mm	2Mt	
	1312365AXX	Çelik yaylı buhar hortumu Ø30mm	2Mt	
UE025YLKIT	UE025YL001	400 V 3 Faz Nemlendirici 25 kg/h On/Off veya 0-10V Oransal Kontrol	1ad.	1.533,50 €
	DP060D30RU	Paslanmaz Çelik Distribütör , inlet Ø40mm, l=600mm	1ad.	
	1312368AXX	Yoğuşma tahliye hortumu Ø10mm	2Mt	
	1312365AXX	Çelik yaylı buhar hortumu Ø40mm	2Mt	
UE035YLKIT	UE035YL001	400 V 3 Faz Nemlendirici 35 kg/h On/Off veya 0-10V Oransal Kontrol	1ad.	1.688,76 €
	DP060D30RU	Paslanmaz Çelik Distribütör , inlet Ø40mm, l=600mm	1ad.	
	1312368AXX	Yoğuşma tahliye hortumu Ø10mm	2Mt	
	1312365AXX	Çelik yaylı buhar hortumu Ø40mm	2Mt	
UE045YLKIT	UE045YL001	400 V 3 Faz Nemlendirici 45 kg/h On/Off veya 0-10V Oransal Kontrol	1ad.	1.688,76 €
	DP060D30RU	Paslanmaz Çelik Distribütör , inlet Ø40mm, l=600mm	1ad.	
	1312368AXX	Yoğuşma tahliye hortumu Ø10mm	2Mt	
	1312365AXX	Çelik yaylı buhar hortumu Ø40mm	2Mt	
UE065YLKIT	UE065YL001	400 V 3 Faz Nemlendirici 65 kg/h On/Off veya 0-10V Oransal Kontrol	1ad.	2.144,26 €
	DP060D30RU	Paslanmaz Çelik Distribütör , inlet Ø40mm, l=600mm	1ad.	
	1312368AXX	Yoğuşma tahliye hortumu Ø10mm	4Mt	
	1312365AXX	Çelik yaylı buhar hortumu Ø40mm	4Mt	
UE090YLKIT	UE090YL001	400 V 3 Faz Nemlendirici 90 kg/h On/Off veya 0-10V Oransal Kontrol	1ad.	3.389,23 €
	DP060D30RU	Paslanmaz Çelik Distribütör , inlet Ø40mm, l=600mm	2ad.	
	1312368AXX	Yoğuşma tahliye hortumu Ø10mm	4Mt	
	1312365AXX	Çelik yaylı buhar hortumu Ø40mm	4Mt	
UE0130YLKIT	UE0130YL001	400 V 3 Faz Nemlendirici 130 kg/h On/Off veya 0-10V Oransal Kontrol	1ad.	4.042,47 €
	DP060D30RU	Paslanmaz Çelik Distribütör , inlet Ø40mm, l=600mm	4ad.	
	1312368AXX	Yoğuşma tahliye hortumu Ø10mm	8Mt	
	1312365AXX	Çelik yaylı buhar hortumu Ø40mm	8Mt	

CAREL ODA TERMOSTATLARI

CAREL

PJEZS * Modelleri, 0 ° C'nin üzerindeki sıcaklıklarda çalışan statik soğutma ünitelerinin (evaporatörde fan yok) yönetimi için tasarlanmıştır.

PJEZC * Modelleri, düşük sıcaklıkta çalışan soğutma ünitelerinin yönetimi için tasarlanmıştır.

Yeni nesil MasterCella, entegre soğuk oda çözümlerine olan ihtiyaca cevaptır.

ON/OFF : ünite dijital girişten veya doğrudan tuş takımından açılıp kapatılabilir



Düz tuş takımı sayesinde temizlenmesi kolaydır

Okunması kolay, yüksek verimli ekran ve geleneksel







Easy Pjez



Master Cella



MODEL	AÇIKLAMA	RÖLE SAYISI	SENSÖR TİPİ	FİYAT
PJEZSO	TEK PROB TERMOSTAT 1 ad.. NTC10K Sensor Dahil	1	NTC10K / PTC	22,08 €
PJEZCO	ÇİFT PROB TERMOSTAT 2 ad.. NTC10K Sensor Dahil	3	NTC10K / PTC	29,12 €

MODEL	AÇIKLAMA	RÖLE SAYISI	FİYAT
MD33D0EN00	MASTER CELLA PANO TİPİ SOĞUK ODA DİJİTAL TERMOSTAT NTC015HP00 X 2AD. SENSÖR DAHİL	5	123,13 €
IROPZSEM10	MASTERCCELLA OPTIONAL SERIAL CARD		35,36 €
BMEST03RE0	BOSS-MINI SUPERVISOR 30 cihaz bağlantı	 	  2.229,57 €

MODEL	AÇIKLAMA			FİYAT
NTC ISI SENSÖRÜ NTC015HP00	NTC 10K	-50oC / 110oC	1,5Mt.	5,14 €
NTC ISI SENSÖRÜ (Metal Uçlu) NTC015WH01	NTC 10K	-50oC / 110oC	1,5Mt.	8,57 €

CAREL

ELEKTRONİK EXPANSİYON VALFLER

CAREL

Yüksek, düşük evaporasyon ve aşırı superheat kontrolü
Yardımlı başlatma prosedürü (sadece 4 parametre değiştirilerek ayar yapılabilir.)
Çıkarılabilir grafik LCD ekran.
Kullanıcı parola yönetimi.
4-20ma basınç transmitter kullanılabilir.
Sökülebilir ekran sayesinde program kopyalama özelliği
Defrost yönetimi için ikinci dijital girişi



MODEL	KAPASİTE KW				AÇIKLAMA	FİYAT
	R134A	R404a	R410a	R407c		
E2V18BSF00	10,3	9	15	13,5	R1234ze R134a R22 R404A R407C R407H R410A R417A R427A R448A R449A R450A R507A R452A R513A R744	180,17 €
E2V24BSM00	21	18	31	27		180,17 €
E2V35BSM00	41	36	61	54		180,17 €
E3V45SSR10	72	63	107	94		356,57 €
E3V55SSR10	104	91	155	136		356,57 €
E3V65SSR10	146	128	217	190		388,75 €
E4V85BST00	205	179	304	265		540,53 €
E4V95BST00	285	249		370		600,10 €
E6V	850	843	1240	1050		972,65 €
E7V	1768	1764	2593	2185		1.245,94 €

Condensing temp.= 43 °C, evaporation temp.= 4 °C SC:1°C

MODEL	BASINÇ ARALIĞI	AÇIKLAMA	FİYAT
SPKT0013P0	-1/9,3 BAR	 5 Vdc ±10% 0.5-4.5 Vdc ratiometric	69,55 €
SPKT00E3P0	-1/12,8 BAR		69,55 €
SPKT0043P0	0/17,3 BAR		69,55 €
SPKT0033P0	0/34,5 BAR		69,55 €
SPKT00B6P0	0/45 BAR		69,55 €
SPKC002310		Transmitter kablosu 2Mt IP67 (EN60529)	8,93 €
E2VCAB0600		E2V CONN&CABLE 6,0MT IP67	20,40 €
EVDIS00EN0		EVDIS00EN0 DISPLAY FOR EVD EVOLUTION	187,85 €
EVD000041		CAREL VALF DRIVER	207,79 €
EVD0000E11		UNIVERSAL VALF DRIVER	286,27 €
EVBAT00400		EVD EVO RECHARGEABLE BATTERY MODULE (WITHOUT BATTERY)	83,61 €
EVDCON0021		CONNECTOR KIT	8,40 €
NTC060WF00		(FAST READING) Superheat Sensörü, 6MT , -50T105 °C	15,91 €

CAREL

Programlanabilir Kontrol Cihazları

Soğutucular ve Isı pompaları

- * Roof-top üniteleri
- * Klimalar
- * Küçük / Orta boy klima santralleri
- * Vitrinler
- * Soğuk odalar
- * Kurutucular
- * Merkezi sistem koproresör kontrolü
- * İsteğe bağlı özel projeler.



CAREL



MODEL	AÇIKLAMA	GİRİŞ / ÇIKIŞ				FİYAT
		AI	AO	DI	DO	
P+300B0000S0	pCO5 + SMALL	5	4	8	8	FİYAT SORUNUZ
P+300B0000M0	pCO5 + MEDIUM	8	4	14	13	
P+300B0000L0	pCO5 + LARGE	10	6	18	18	
P+300B0000Z0	pCO5 + EXTRA LARGE	8	4	14	29	
P+300B0000ES0	pCO5 + SMALL (Ekranlı)	5	4	8	8	
P+300B0000EM0	pCO5 + MEDIUM (Ekranlı)	8	4	14	13	
P+300B0000EL0	pCO5 + LARGE (Ekranlı)	10	6	18	18	
P+300B0000EZ0	pCO5 + EXTRA LARGE (Ekranlı)	8	4	14	29	
PCO5CON1S0	pCO5 + SMALL Konnektör					17,94 €
PCO5CON1M0	pCO5 + MEDIUM Konnektör					18,72 €
PCO5CON1L0	pCO5 + LARGE Konnektör					25,55 €
PCO5CON1Z0	pCO5 + EXTRA LARGE Konnektör					47,30 €
PCOS004850	RS485 serial card					120,64 €
PCO1000F0	LonWorks® serial card					276,26 €
PCO1000BA0	BACnet™ MSTP RS485 interface card					458,06 €
PCOS00HBB0	CANbus serial card					197,98 €
PCO1000WB0	Ethernet serial card					305,12 €
PCO100TLN0	tLAN and PST card					56,04 €
PCO100MPB0	MP-Bus card					54,44 €
PGD1000FW0	Beyaz Led Uzak Ekran (132x64 pixel)					271,29 €
PGD1000FX0	Beyaz Led Uzak Ekran + Buzzer (132x64 pixel)					379,43 €
PLD00GFP00	Beyaz Likit Kristal Ekran (132x64 pixel)					106,93 €

CR SERİSİ R404A

HERMETİK KOMPRESÖRLER

+7,2 °C / -20 °C (MBP)

Düşük Ses

Ultra Verimlilik

Üstün ve Kanıtlanmış Güvenilirlik

Geniş Çalışma Aralığı



MODEL	DISP. CC	NOMİNAL GÜÇ	VOLTAJ	EMME BASMA	Yağ Miktarı (Lt)	FİYAT	
CR22K6ME-PF1-111 (K)	40,8	1,5 Hp	220 V	5/8"	3/8"	1,33	387,94 \$
CR24K6ME-PFZ-135 (R)	44,28	2 Hp	220 V	5/8"	3/8"	1,33	396,34 \$
CR30K6ME-PF1-135 (R)	51,47	2,5 Hp	220 V	5/8"	3/8"	1,33	427,85 \$
CR34K6ME-PFZ-135 (R)	59,66	3 Hp	220 V	3/4"	3/8"	1,33	432,26 \$
CR22K6ME-TFM-111 (K)	40,8	1,5 Hp	380 V	5/8"	3/8"	1,33	383,90 \$
CR24K6ME-TFD-132 (R)	44,28	2 Hp	380 V	5/8"	3/8"	1,33	392,69 \$
CR30K6ME-TFM-111 (K)	51,47	2,5 Hp	380 V	5/8"	3/8"	1,33	419,06 \$
CR34K6ME-TFD-132 (R)	59,66	3 Hp	380 V	3/4"	3/8"	1,33	421,99 \$
CR42K6ME-TFM-132 (R)	72,09	3,5 Hp	380 V	3/4"	3/8"	1,33	445,44 \$
CR47KQME-TFD-201 (K)	78,78	4 Hp	380 V	7/8"	1/2"	1,33	504,05 \$
CR53KQME-TFD-203 (K)	88,28	4,5 Hp	380 V	7/8"	1/2"	1,33	527,49 \$
CR57KQME-TFD-203 (K)	94,61	5 Hp	380 V	7/8"	1/2"	1,33	556,27 \$
CR62KQME-TFD-203 (K)	101,92	6 Hp	380 V	7/8"	1/2"	1,33	580,94 \$
CR72KQME-TFM-233 (R)	115,79	7 Hp	380 V	7/8"	1/2"	1,33	747,27 \$

* Rotalock Vanalar fiyata dahil değildir.

* Tüm modeller karter ısıtıcılıdır ve fiyata dahildir.

CR SERİSİ KAPASİTE TABLOSU

MODEL	Kond. °C	Evaporasyon Sıcaklığı °C						Kapasite (Watt)			
		-25	-20	-15	-10	-5	0	5	10	12,8	
CR22K6ME-PF1	45	796	1314	1880	2515	3240	4077	5047	6172	6878	
	50		1020	1543	2119	2770	3515	4378		6011	
CR24K6ME-PFZ	45	901	1383	1994	2689	3423	4154	4836	5425	5697	
	50		1134	1682	2315	2986	3655	4272	4796	5032	
CR30K6ME-PF1	45	1187	1801	2507	3306	4184	5148	6190	7309	7967	
	50		1501	2131	2843	3631	4496	5431	6434	7026	
CR34K6ME-PFZ	45										
	50										
CR22K6ME-TFM	45	815	1347	1925	2576	3319	4176	5170	6323	7045	
	50		1045	1580	2170	2837	3600	4485	5513	6157	
CR24K6ME-TFD	45	851	1405	2010	2689	3464	4359	5397	6600	7355	
	50		1090	1650	2265	2961	3759	4682	5753	6427	
CR30K6ME-TFM	45	1209	1840	2560	3372	4264	5247	6316	7469	8150	
	50		1533	2176	2898	3701	4582	5541	6575	7188	
CR34K6ME-TFD	45										
	50										
CR42K6ME-TFM	45	1731	2617	3666	4894	6311	7933	9771	11837	13100	
	50		2134	3074	4172	5436	6884	8525	10375	11506	
CR47KQME-TFD	45	2531	3496	4670	6096	7824	9891	12346	15231	17052	
	50		2898	3939	5236	6836	8782	11118	13890	15649	
CR53KQME-TFD	45	2835	3917	5233	6833	8766	11084	13834	17067	19108	
	50		3247	4414	5867	7661	9840	12458	15565	17536	
CR57KQME-TFD	45	3156	4361	5825	7605	9758	12335	15398	18997	21268	
	50		3615	4912	6531	8525	10952	13867	17323	19517	
CR62KQME-TFD	45	3474	4801	6412	8372	10740	13579	16948	20911	23411	
	50		3978	5407	7189	9386	12507	15265	19069	21484	
CR72KQME-TFM	45										
	50										

CAPACITOR START CAPACITOR RUN (CSCR)

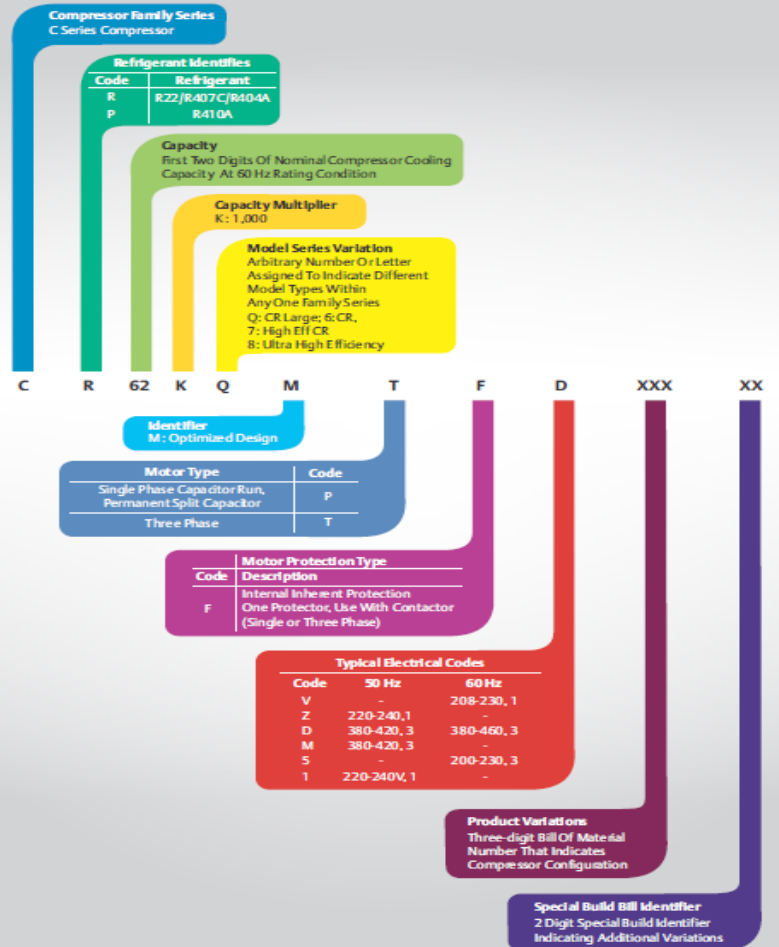
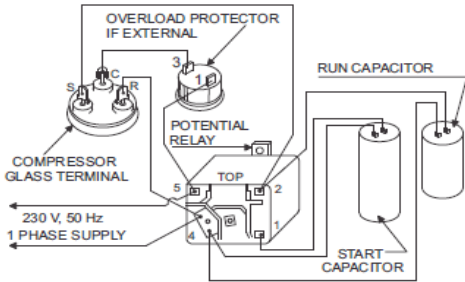

CS SERİSİ R404A

HERMETİK KOMPRESÖRLER

0°C / -30 °C (LBP)



Düşük Ses
Ultra Verimlilik
Üstün ve Kanıtlanmış Güvenilirlik
Geniş Çalışma Aralığı



MODEL	DISP. CC	NOMİNAL GÜÇ	VOLTAJ	EMME BASMA		BAĞLANTI	FİYAT
CS10 K6ME PFZ 135	38,1	1,5 Hp	220 V Tek Faz	3/4"	3/8"	Rotalock	404,42 \$
CS11 K6ME PFZ		1,8 Hp		3/4"	3/8"	Rotalock	407,33 \$
CS13 K6ME PF1		2 Hp		3/4"	3/8"	Rotalock	439,58 \$
CS17 K6ME PFZ		3 Hp		3/4"	1/2"	Rotalock	465,94 \$
CS10 K6ME TFM 132	38,1	1,5 Hp	380 V 3 Faz	5/8"	3/8"	Rotalock	413,19 \$
CS11 K6ME TFM 132		2 Hp		5/8"	3/8"	Rotalock	427,85 \$
CS13 K6ME TFM 132		2,5 Hp		5/8"	3/8"	Rotalock	436,65 \$
CS17 K6ME TFM 132		3 Hp		3/4"	3/8"	Rotalock	454,23 \$
CS20 K6ME TFM 132	74,3	3,5 Hp		5/8"	3/8"	Rotalock	465,94 \$
CS27 KQME TFD 203	92,4	4 Hp		5/8"	3/8"	Rotalock	565,59 \$
CS33 KQME TFD 233	106	5 Hp		3/4"	3/8"	Rotalock	583,17 \$

* Monofaze modellerde elektrik kutusu fiyata dahildir.

* Rotalock vanalar fiyata dahil değildir.

* Tüm modeller karter ısıtıcılıdır ve fiyata dahildir.

CS SERİSİ KAPASİTE TABLOSU

MODEL	Kond. °C	Evaporasyon Sıcaklığı °C											
		-32	-29	-26	-23	-21	-18	-15	-12	-10	-7	-4	-1
CS10 K6ME PF1	45	142	412	684	964	1254	1559	1880	2223	2515	2986	3414	3879
	54,4		1020	171	429	689	950	1218	1498	1731	2101	2434	2793
CS11 K6ME PFZ	45	154	445	740	1042	1355	1684	2031	2400	2689	3225	3688	4189
	54,4			185	465	743	1026	1316	1618	1870	2270	2629	3016
CS13 K6ME PF1	45	186	541	900	1268	1649	2049	2472	2922	3306	3926	4488	5099
	54,4			224	564	904	1248	1602	1969	2276	2764	3200	3671
CS17 K6ME PFZ	45	948	1099	1360	1713	2141	2627	3156	3713	4165	4836	5369	5863
	54,4			807	1051	1369	1742	2157	2595	2951	3477	3888	4255
CS10 K6ME TFM	45	145	422	702	988	1285	1597	1925	2277	2576	3060	3498	3973
	54,4			176	440	705	973	1248	1534	1773	2154	2494	2860
CS11 K6ME TFM	45	154	445	740	1042	1355	1684	2031	2400	2689	3225	3688	4189
	54,4			185	465	743	1026	1316	1618	1870	2270	2629	3016
CS13 K6ME TFM	45	189	552	917	1292	1682	2090	2520	2981	3372	4005	4578	5201
	54,4			229	576	923	1273	1634	2008	2321	2819	3265	3744
CS17 K6ME TFM	45	970	1125	1392	1753	2191	2689	3231	3800	4263	4950	5497	6002
	54,4			826	1076	1401	1783	2207	2655	3022	3559	3980	4357
CS20 K6ME TFM	45	828	1291	1739	2189	2658	3162	3718	4339	4894	5845	6764	7815
	54,4			894	1285	1676	2082	2522	3010	3445	4195	4925	5768
CS27 KQME TFD	45	1761	2021	2690	3237	3845	4522	5274	6105	6833	8036	9145	10362
	54,4			1871	2264	2709	3212	3778	4415	4978	5922	6805	7781
CS33 KQME TFD	45	2157	2696	3297	3965	4711	5541	6461	7481	8372	9844	11206	12694
	54,4			2292	2774	3319	3934	4629	5409	6099	7255	8336	9534

Operating Map

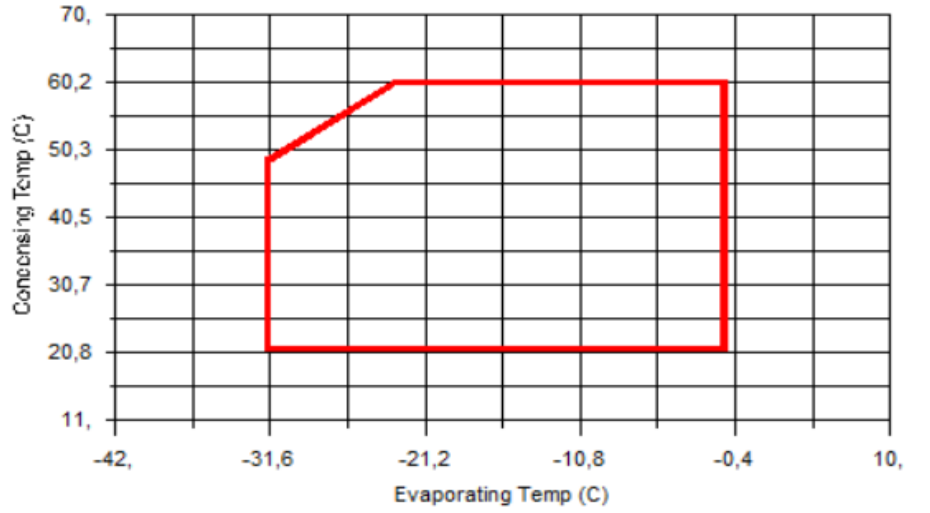

CAPACITOR START CAPACITOR RUN (CSCR)

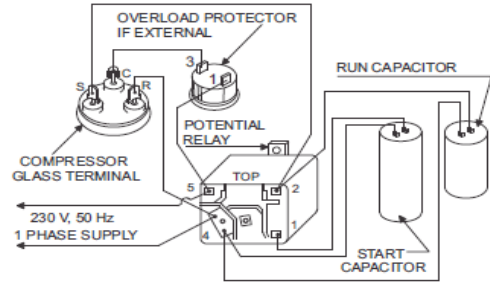

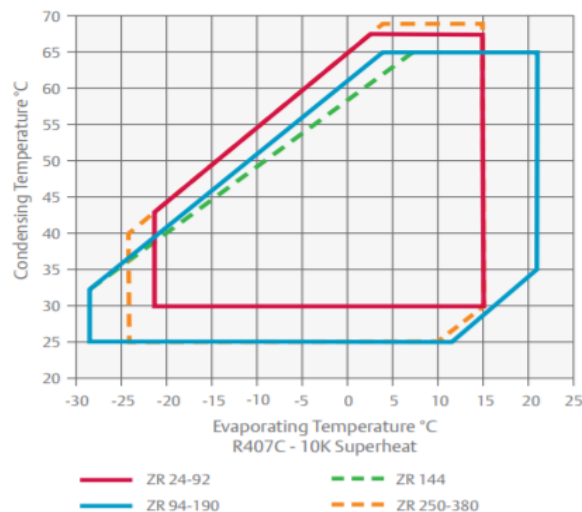
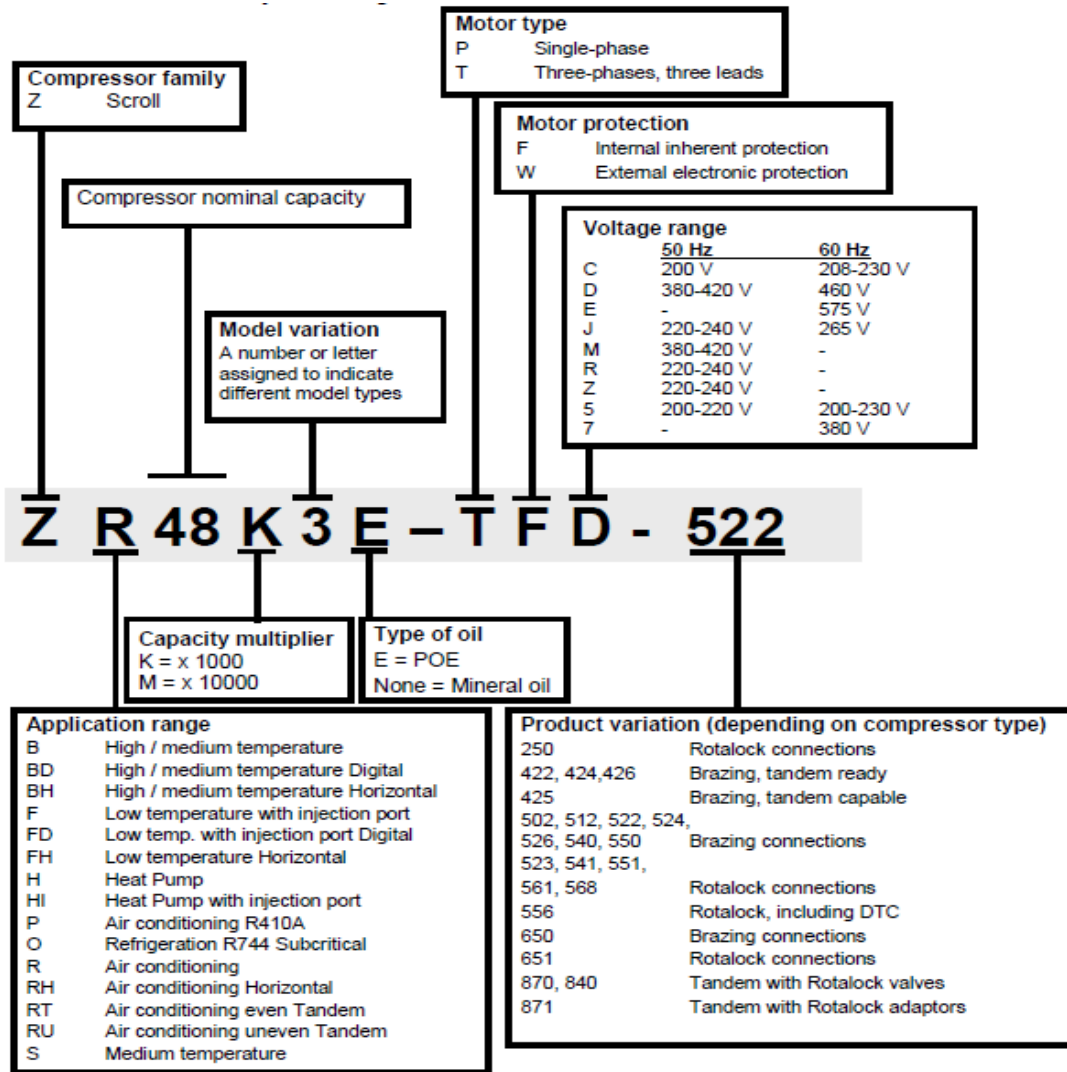

ZR SERİSİ R407c-R134a

SCROLL KOMPRESÖRLER
+12°C / -20 °C (HBP)



Düşük Ses
Ultra Verimlilik
En Geniş Üstün ve Kanıtlanmış Güvenilirlik
Tandem veya Trio çalışabilirlik



MODEL	NOMİNAL GÜÇ	Kw (50 Hz.) R407C	Kw (50 Hz.) R134a	VOLTAJ	EMME / BASMA	GAZ	FİYAT	
ZR22 K3E PFJ 522	1,8 HP	4,5	3,2	220 V	3/4"	R407C R134a	485,97 €	
ZR28 K3E PFJ 522	2,4 HP	5,9	4,2				512,59 €	
ZR34 K3E PFJ 522	2,8 HP	7,0	4,9				537,36 €	
ZR40 K3E PFJ 522	3,4 HP	8,2	5,7				673,61 €	
ZR34 K3E TFD 522	2,8 HP	7,0	4,9	380 V	1/2"	R407C R134a	556,18 €	
ZR40 K3E TFD 522	3,4 HP	8,2	5,7				426,05 €	
ZR48 K3E TFD 522	4 HP	10,1	5,9		7/8"		TANDEM	658,05 €
ZR61 KCE TFD 522	5 HP	12,8	8,9					653,37 €
ZR72 K3E TFD 522	6 HP	14,8	10,5	3/4"	R407C R134a	743,62 €		
ZR81 K3E TFD 522	6,5 HP	16,7	11,7			857,85 €		
ZR48 K3E TFD 422	4 HP	10,1	5,9	380 V		7/8"	TANDEM	922,53 €
ZR61 KCE TFD 422	5 HP	12,8	8,9					986,42 €
ZR72 KCE TFD 422	6 HP	14,8	10,5		3/4"	R407C R134a		1.120,63 €
ZR81 KCE TFD 422	6,5 HP	16,7	11,7					1.255,42 €
ZR 94 KCE TFD 455	8 HP	20,6	13,9	380 V	1 1/8"		R407C R134a	1.120,82 €
ZR108 KCE TFD 455	9 HP	23,0	15,6					1.286,04 €
ZR125 KCE TFD 455	10 HP	27,0	18,2		1 3/8"	7/8"		1.389,91 €
ZR144 KCE TFD 455	12 HP	30,9	21,0					1.463,04 €
ZR160 KCE TFD 455	13 HP	33,5	22,8					1.591,82 €
ZR190 KCE TFD 455	15 HP	39,3	27,2					1.759,15 €
ZR250 KCE TWD 523	20 HP	52,2	35,4	380 V	1 5/8"		R407C R134a	2.553,60 €
ZR310 KCE TWD 523	25 HP	65,0	43,8					2.879,97 €
ZR380 KCE TWD 523	30 HP	81,7	55,4			3.284,28 €		

Evap. 5°C, Condensing 50°C, 0K SubCooling, 10K SuperHeat

ZP SERİSİ R410A

SCROLL KOMPRESÖRLER

+15 °C / -25 °C (HBP)



Pazarın En Geniş Kapasite Aralığı
Ultra Verimlilik
En Geniş Üstün ve Kanıtlanmış Güvenilirlik
Tandem veya Trio çalışabilirlik
Isı pompası uygulamaları 5K çalışma zarfı
Düşük ses ve titreşim seviyesi



•Barkodu okutarak ürün kullanım kılavuzuna ulaşabilirsiniz.



MODEL	NOMİNAL GÜÇ		Kw (50 Hz.)	VOLTAJ	EMME / BASMA		ÇALIŞMA REJİMİ	FİYAT
			R410A					
ZP24 K5E PFJ 522	1,9	HP	5,1	220V	3/4"	+12,5°C / -20 °C	657,16 €	
ZP29 K5E PFJ 522	2,5	HP	6,1				7/8"	622,54 €
ZP31 K5E PFJ 522	2,7	HP	6,5		1/2"		727,50 €	
ZP36 K5E PFJ 522	2,9	HP	7,9				758,82 €	
ZP24 K5E TFD 522	1,9	HP	5,1	380V	3/4"		676,95 €	
ZP36 K5E TFD 522	2,9	HP	7,9				7/8"	691,20 €
ZP42 K5E TFD 522	3,5	HP	9,0		726,93 €			
ZP54 K5E TFD 522	4,6	HP	11,6		741,84 €			
ZP61 K5E TFD 522	5	HP	13,1		823,63 €			
ZP72 KCE TFD 522	6	HP	15,3		1 1/8"		845,23 €	
ZP83 KCE TFD 522	7	HP	17,7				880,55 €	
ZP91 KCE TFD 522	8	HP	19,3		7/8"		1.056,86 €	
ZP104 KCE TFD 455	9	HP	22,7			1.093,54 €		
ZP122 KCE TFD 455	10	HP	26,5			1.122,95 €		
ZP143 KCE TFD 455	12	HP	31,5			1.171,45 €		
ZP154 KCE TFD 455	13	HP	33,5		1 3/8"	1.205,25 €		
ZP182 KCE TFD 455	15	HP	39,6			1.349,29 €		
ZP232 KZE TED 456	20	HP	50,6		1 1/8"	1.927,05 €		
ZP292 KZE TED 456	25	HP	63,5			2.264,39 €		
ZP385 KCE TWD 522	30	HP	82,4		1 5/8"	+15 °C / -24 °C	3.384,54 €	
ZP485 KCE TWD 522	40	HP	105,0	1 3/8"			4.056,70 €	
ZP725 KCE FED 522	50	HP	160,0				2 1/8"	8.974,66 €

EN12900 R410A: Evaporating 5°C, Condensing 50°C, Superheat 10K, Subcooling 0K

522 Kaynaklı model.

455 Tandem olabilen, yağ gözetleme camlı kaynaklı model.

ZB SERİSİ R404A - R448A - R449A

SCROLL KOMPRESÖRLER
+10 °C / -25 °C (LBP-HBP)



Son derece Sessiz
%15 daha yüksek verim
Üstün ve Kanıtlanmış Güvenilirlik
Çoklu soğutkan kullanımı
Geniş çalışma alanı
•Barkodu okutarak ürün kullanım kılavuzuna ulaşabilirsiniz.



MODEL	NOMİNAL GÜÇ	VOLTAJ	EMME BASMA	GAZ	ÇALIŞMA REJİMİ	FİYAT
ZB15 KCE TFD 551	1,5 HP	380V	7/8"	R-134a R-22 R-404A R-407A R-407F R-448A R-449A R-450A R-513A	+10°C / -25°C	542,49 €
ZB19 KCE TFD 551	2 HP					549,99 €
ZB21 KCE TFD 551	3 HP					554,42 €
ZB26 KCE TFD 551	3,5 HP					618,15 €
ZB29 KCE TFD 551	4 HP					654,70 €
ZB38 KCE TFD 551	5 HP					752,14 €
ZB45 KCE TFD 551	6 HP					836,66 €
ZB48 KCE TFD 591	6,5 HP		1.105,35 €			
ZB57 KCE TFD 591	8 HP		1.466,64 €			
ZB66 KCE TFD 551	9 HP		1.806,19 €			
ZB76 KCE TFD 551	10 HP		2.004,36 €			
ZB95 KCE TFD 551	13 HP		2.239,51 €			
ZB114 KCE TFD 551	15 HP		2.428,17 €			
ZB220 KCE TWM 523	30 HP		1 5/8" 1 3/8"			R-404A / R-448A / R-449A

ZB MODELLERDE ROTALOCK EMME VE BASMA VANALARI İLE KARTER ISITICISI FİYATA DAHİL DEĞİLDİR.

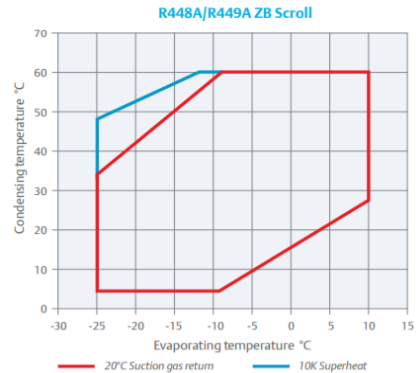
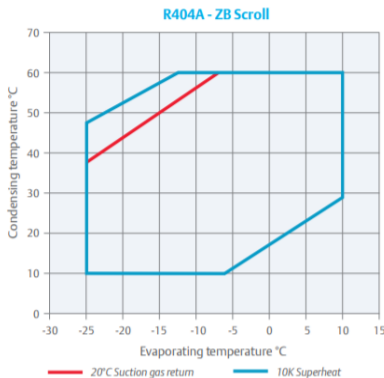

ZBD SERİSİ R404A

DIGITAL SCROLL KOMPRESÖRLER
+5 °C / -40 °C (HBP/LBP)



Düşük Ses
Ultra Verimlilik
Üstün ve Kanıtlanmış Güvenilirlik
Tandem veya Trio çalışabilirlik



MODEL	NOMİNAL GÜÇ	VOLTAJ	EMME BASMA		GAZ	ÇALIŞMA REJİMİ	FİYAT
ZBD21 KCE TFD 551	3 HP	380 V	7/8"	3/4"	R22 R404A	+5°C / -40°C	Fiyat Sorunuz
ZBD30 KCE TFD 551	4 HP						Fiyat Sorunuz
ZBD38 KCE TFD 551	5 HP						Fiyat Sorunuz
ZBD45 KCE TFD 551	6 HP		1 1/8"	7/8"			Fiyat Sorunuz
ZBD58 KCE TFD 551	8 HP						Fiyat Sorunuz
ZBD76 KCE TFD 551	10 HP						Fiyat Sorunuz
ZFD18 KVE TFD 551	6 HP		7/8"	3/4"			Fiyat Sorunuz

MODEL	NOMİNAL GÜÇ	VOLTAJ	EMME BASMA		GAZ	ÇALIŞMA REJİMİ	FİYAT
ZPD34 KSE TFM 522	3 HP	380 V	7/8"	1/2"	R410A	+15°C / -27°C	1.604,36 €
ZPD42 KSE TFM 522	3,5 HP						1.673,58 €
ZPD54 KSE TFM 522	4,5 HP						1.851,45 €
ZPD61 KCE TFD 522	5 HP			1.990,77 €			
ZPD72 KCE TFD 522	5 HP			2.192,30 €			
ZPD83 KCE TFD 522	6 HP			2.371,05 €			
ZPD91 KCE TFD 522	7,5 HP		3/4"	2.597,12 €			
ZPD104 KCE TFD 455	9 HP		11/8"	7/8"			3.440,02 €
ZPD122 KCE TFD 455	10 HP						3.843,10 €
ZPD137 KCE TFD 455	12 HP						4.669,38 €
ZPD154 KCE TFD 455	13 HP		13/8"	7/8"			4.913,84 €
ZPD182 KCE TFD 455	15 HP						5.228,41 €

ZF SERİSİ R404A / R448 / R449

BUHAR ve LİKİT ENJEKSİYONLU SCROLL KOMPRESÖRLER
+7 °C / -40 °C (HBP/LBP) (380-420V 50Hz. 460V 60Hz.)



Düşük Ses
Ultra Verimlilik
Üstün ve Kanıtlanmış Güvenilirlik
Tandem veya Trio çalışabilirlik



*Barkol'dan farklı ürün bulabilirsiniz. MODEL	NOMİNAL GÜÇ	Disp. (M3/h)	Yağ Miktarı(Lt)	EMME/BASMA		Kg	Maksimum Çalışma Akımı	FİYAT
ZF06 K4E TFD 556	2 Hp	5,9	1,3	7/8"	5/8"	25,40	5	1.029,24 €
ZF08 K4E TFD 556	2,5 Hp	7,3	1,5	7/8"	5/8"	27,20	6	1.097,14 €
ZF09 K4E TFD 556	2,8 Hp	8	1,5	7/8"	5/8"	27,00	6	1.165,56 €
ZF11 K4E TFD 556	3,5 Hp	9,9	1,5	7/8"	5/8"	28,00	7	1.249,03 €
ZF13 K4E TFD 556	4 Hp	11,8	1,9	7/8"	5/8"	38,00	8	1.317,48 €
ZF15 K4E TFD 556	5 Hp	14,5	1,9	7/8"	5/8"	39,00	10	1.453,80 €
ZF18 K4E TFD 556	6 Hp	17,1	1,9	7/8"	5/8"	41,00	12	1.563,69 €

BUHAR ENJEKSİYON

ZF13 KVE TFD 556	4 Hp	11,7	1,9	7/8"	5/8"	38,00	9	1.639 €
ZF18 KVE TFD 556	6 Hp	17,1	1,9	7/8"	5/8"	39,50	13	2.052 €

LİKİT VE BUHAR ENJEKSİYON

ZF25 K5E TFD 567	7,5 Hp	21,4	1,9	11/8"	3/4"	39,50	16	1.672,97 €
ZF34 K5E TFD 567	10 Hp	29,1	3,4	13/8"	7/8"	63,10	25	2.334,72 €
ZF41 K5E TFD 567	13 Hp	35,3	3,4	13/8"	7/8"	63,1	29	2.585,73 €
ZF49 K5E TFD 567	15 Hp	42,4	3,4	13/8"	7/8"	66,2	30	2.783,90 €
ZF54 K5E TFD 568	17 Hp	48,3	3,4	13/8"	7/8"	66,2	31	2.894,38 €

* ROTALOCK VALFLER VE KARTER ISITICISI FİYATA DAHİL DEĞİLDİR.

* EVI MODELLERİNDE HEAT EXCHANGER, SOLENOİD VALF VE EXP. VALF GEREKMEKTEDİR. FİYATA DAHİL DEĞİLDİR.

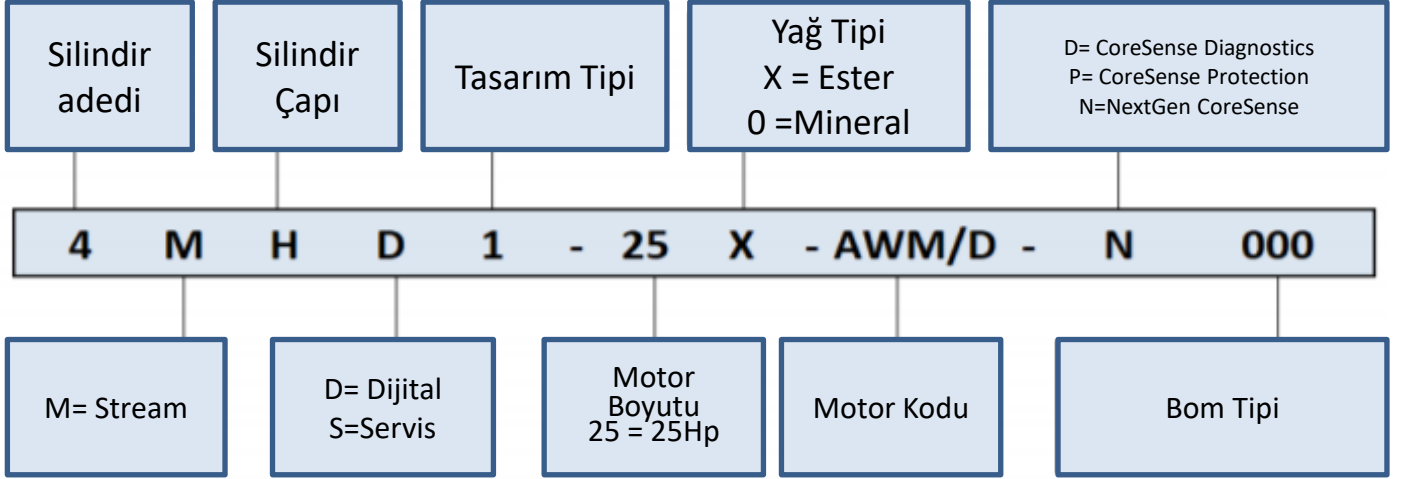

COPELAND

SEMİ HERMETİK STREAM KOMPRESÖRLER 4MF-13X to 6MK-50X



Düşük Ses
Ultra Verimlilik
Üstün ve Kanıtlanmış Güvenilirlik
Tandem veya Trio çalışabilirlik



MODEL	NOMİNAL GÜÇ	ÇALIŞMA ARALIĞI R404A	Hz.	GAZ	EMME / BASMA	VOLTAJ	PİSTON SAYISI	DISP. m ³ /h	FİYAT
4MF-13X AWM/D	13	Low	25Hz - 75Hz	R404A - R134A - R407C - R22	1 5/8" 11/8"	380 V - 420 V 50HZ	4	62	4.263 €
4MA-22X AWM/D	22	High					4	62	4.723 €
4ML-15X AWM/D	15	Low					4	71	4.455 €
4MH-25X AWM/D	25	High					4	71	5.276 €
4MM-20X AWM/D	20	Low					4	78	4.756 €
4MI-30X AWM/D	30	High					4	78	5.540 €
4MT-22X AWM/D	22	Low			4		88	5.109 €	
4MJ-33X AWM/D	33	High			4		88	5.899 €	
4MU-25X AWM/D	25	Low			4		99	5.644 €	
4MK-35X AWM/D	35	High			4		99	6.510 €	
6MM-30X AWM/D	30	Low			6		120	6.441 €	
6MI-40X AWM/D	40	High			6		120	7.172 €	
6MT-35X AWM/D	35	Low			6		135	7.307 €	
6MJ-45X AWM/D	45	High			6		135	7.522 €	
6MU-40X AWM/D	40	Low			6		153	7.893 €	
6MK-50X AWM/D	50	High			6		153	8.376 €	

KARTER ISITICISI KOMPRESÖR FİYATINA DAHİLDİR

High = +7°C / -45°C

Low = -5°C / -50°C

DISCUS VALF TEKNOLOJİSİ



ALCO ELECTRONIC EXPANSION VALFLER

EX4, EX5, EX6, EX7, EX8



Full hermetik dizayn
Adımlı motor
Kısa açma ve kapama süresi
Çoklu soğutkan kullanımı
Yüksek ve tam likit geçişi



Barkodu okutarak ürün kullanım kılavuzuna ulaşabilirsiniz.

MODEL	BAĞLANTI ÇAPI Ø	KAPASİTE Kw R407C	KAPASİTE kW R22	KAPASİTE kW R134a	KAPASİTE kW R404	KAPASİTE kW R410	FİYAT
EX4-I21	3/8" - 5/8"	2 - 17,4	2 - 16,5	1 - 12,8	1 - 11,5	2 - 17,8	241,41 €
EX5-U21	5/8" - 7/8"	5-53	5-50	4-39	4-35	5-54	246,77 €
EX6-I21	7/8" - 1 1/8"	15-126	15-120	10-93	10-84	13-130	281,61 €
EX7-I21	1 1/8" - 1 3/8"	35-347	35-330	25-255	25-230	-	367,46 €
EX8-I21	1 5/8"-1 5/8"	100-925	90-880	70-680	60-613	-	670,53 €

UNIVERSAL, CONFIGURABLE DRIVER VE AKSESUARLAR

EXD-U01	Universal Driver	338,81 €
ECP-024	Pil Modülü (Stand-alone driver için)	325,53 €
ECD-002	Dijital Ekran	99,22 €
EC3-X33	Superheat Control	338,67 €
ECN-N60	Isı Sensörü	24,58 €
ECD-002	Dijital Ekran	99,22 €

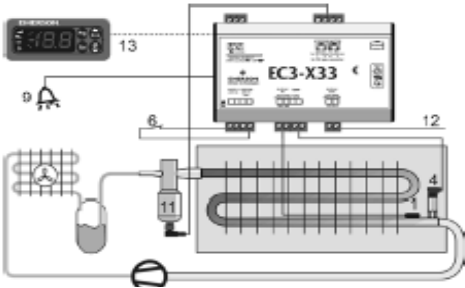

ALCO

DEĞİŞEBİLİR ORİFİSLİ EXPANSION VALFLER



Lazer kaynaklı diyafram
İnce dişler sayesinde kolay ve hassas kızdırma ayarı
Lazer baskılı etiket
Kılcal boru uzunluğu 1,5 m
Maks. çalışma basıncı PS: 45 bar
Sıcaklık aralığı TS: -45 ... + 75 ° C



Barkodu okutarak ürün kullanım kılavuzuna ulaşabilirsiniz.



ORİFİS

ORİFİS	R134a	R22	R404A	R407C	R410	R448A	R449A	R513A R450A	R1234ze	R452A	FİYAT
	KW	KW	KW	KW	KW	KW	KW	KW	KW	KW	
TIO-00X	0,3	0,5	0,4	0,5	0,60	0,50	0,49	0,30	0,23	0,40	8,74 €
TIO-000	0,80	1,30	1,00	1,4	1,50	1,30	1,27	0,70	0,63	1,00	
TIO-001	1,90	3,20	2,3	3,5	3,7	3,19	3,12	1,70	1,49	2,40	
TIO-002	3,10	5,30	3,9	5,7	6,2	5,28	5,16	2,80	2,42	4,00	
TIO-003	5,00	8,50	6,2	9,2	9,90	8,48	8,28	4,50	3,91	6,40	
TIO-004	8,30	13,90	10,1	15,00	16,2	13,86	13,54	7,50	6,49	10,50	
TIO-005	10,10	16,90	12,3	18,30	19,70	16,85	16,46	9,10	7,90	12,80	
TIO-006	11,70	19,50	14,2	21,10	22,80	19,44	19,00	10,60	9,15	14,80	

* Kapasite değerleri +4 °C evaporasyon ve +38 °C kondansasyon şartlarındadır.

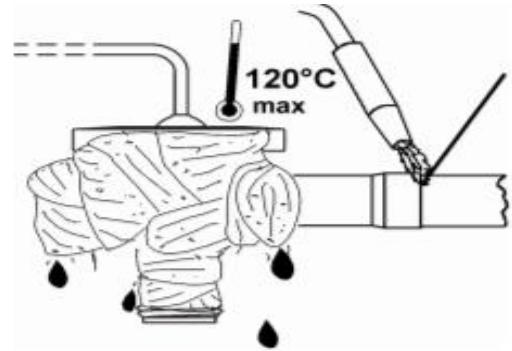
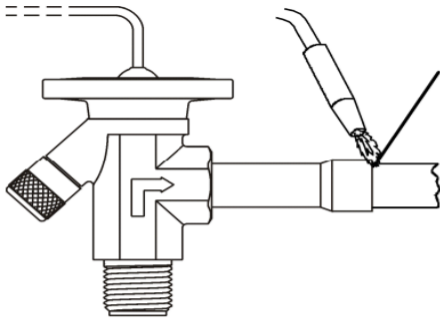

ALCO

DEĞİŞEBİLİR ORİFİSLİ EXPANSION VALFLER



GAZ TİPİ	BAĞLANTI	DIŞTAN DENGE	İÇTEN DENGE	MOP	EVAPORASYON SICAKLIĞI °C	FİYAT
R 404A/ R 507	KAYNAKLI		TIS-SW	-	-45°C.....+20°C	36,17 €
		TISE-SW		-	-45°C.....+20°C	36,26 €
		TISE-SAD10		+10°C	-45°C.....+0°C	100,42 €
		TISE-SW75		0°C	-45°C.....-3°C	91,30 €
		TISE-SAD20		-20°C	-45°C.....-27°C	91,30 €
	REKORLU		TI-SAD10	+10°C	-45°C.....+0°C	39,03 €
			TI-SW	-	-45°C.....+20°C	34,56 €
			TIE-SW	-	-45°C.....+20°C	39,96 €
			TIE-SAD10	+10°C	-45°C.....+0°C	55,83 €
			TIE-SW75	0°C	-45°C.....-3°C	91,30 €
			TIE-SAD20	-20°C	-45°C.....-27°C	55,85 €

R 134A	KAYNAKLI		TIS-MW	-	-45°C.....+20°C	36,19 €
		TISE-MW		-	-45°C.....+20°C	76,13 €
		TISE-MW55		+14°C	-45°C.....+11°C	91,30 €
	REKORLU		TI-MW	-	-45°C.....+20°C	34,56 €
			TI-MW55	+14°C	-45°C.....+11°C	58,01 €
			TIE-MW	-	-45°C.....+20°C	38,01 €
			TIE-MW55	+14°C	-45°C.....+11°C	91,30 €

R 407C	KAYNAKLI		TIS-NW	-	-45°C.....+20°C	48,36 €
		TISE-NW		-	-45°C.....+20°C	76,13 €
	REKORLU		TI-NW	-	-45°C.....+20°C	34,56 €
		TIE-NW		-	-45°C.....+20°C	39,96 €

R 22	KAYNAKLI		TIS-HW	-	-45°C.....+20°C	53,31 €
		TISE-HW		-	-45°C.....+20°C	41,57 €
		TISE-HW 100		+15°C	-45°C.....+13°C	76,13 €
	REKORLU		TI-HW	-	-45°C.....+20°C	34,56 €
		TIE-HW		-	-45°C.....+20°C	39,96 €
		TIE-HAD10		+10°C	-45°C.....+0°C	62,04 €

R 410A	KAYNAKLI PAS.ÇELİK	TILE-ZW		-	-35°C.....+15°C	41,59 €
		TILE-ZW 175		+16,4°C	-35°C.....+15°C	74,23 €

ALCO DEĞİŞEBİLİR ORİFİSLİ VE FLANŞLI BÜYÜK GÖVDELİ EXPANSION VALF



Mükemmel stabilite
Yüksek kapasite, büyük diyafram Yüksek kaliteli metaryaller ile
hassasiyet ve uzun ömür.
Heat pump uygulamaları için uygun. TCLE ve TJRE bulb uzunlukları
1,5mt, TERE, TIRE ve THRE bulb uzunlukları 3mt.
Çalışma aralığı -45oC.....+65oC



Barkodu okutarak ürün kullanım kılavuzuna
ulaşabilirsiniz.

SERİ	R 22			R 134a			R 404A/R 507			R 407C			Orifice
	MODEL	KW	FİYAT	MODEL	KW	FİYAT	MODEL	KW	FİYAT	MODEL	KW	FİYAT	
TCLE	50 HW	1.9	133,29 €	25 MW	1.5	133,29 €	25 SW	1.3	133,29 €	50 NW	2.1	133,23 €	X22440-B1B
	100 HW	3.7	133,29 €	75 MW	2.9	133,29 €	75 SW	2.6	133,29 €	100 NW	4.0	166,54 €	X22440-B2B
	200 HW	7.9	133,29 €	150 MW	6.1	133,29 €	150 SW	5.6	133,29 €	200 NW	8.5	179,28 €	X22440-B3B
	250 HW	11.9	133,29 €	200 MW	9.3	133,29 €	200 SW	8.4	133,29 €	300 NW	12.9		X22440-B3,5B
	300 HW	17.3	133,29 €	250 MW	13.5	133,29 €	250 SW	12.2	133,29 €	400 NW	18.7	166,53 €	X22440-B4B
	500 HW	22.2	133,29 €	350 MW	17.3	133,29 €	400 SW	15.7	133,29 €	550 NW	24.0	166,53 €	X22440-B5B
	750 HW	30.4	133,29 €	550 MW	23.6	133,29 €	600 SW	21.5	133,29 €	750 NW	32.9	166,51 €	X22440-B6B
	1000 HW	41.1	133,29 €	750 MW	32	133,29 €	850 SW	29	133,29 €	1000 NW	44.4	166,59 €	X22440-B7B
	1200 HW	47.8	133,29 €	900 MW	37.2	133,29 €	1000 SW	33.8	133,29 €	1150 NW	51.7	166,59 €	X22440-B8B

TJRE	14 HW	58	149,25 €	11 MW	45	169,29 €	12 SW	40	149,25 €	14 NW	62	169,59 €	X11873-B4B
	18 HW	74	149,25 €	13 MW	57	169,30 €	14 SW	51	149,38 €	17 NW	80	169,59 €	X11873-B5B

TERE	22 HW	91	243,79 €	16 MW	71	243,77 €	18 SW	63	243,77 €	21 NW	99	275,40 €	X9117-B6B
	26 HW	104	243,79 €	19 MW	81	243,79 €	20 SW	72	243,77 €	25 NW	112	275,40 €	X9117-B7B
	35 HW	143	243,79 €	25 MW	112	243,79 €	27 SW	99	243,77 €	33 NW	155	275,40 €	X9117-B8B
	45 HW	174	243,79 €	31 MW	135	243,77 €	34 SW	120	243,79 €	42 NW	188	275,40 €	X9117-B9B

TIRE	55 HW	223	249,22 €	45 MW	174	249,22 €	47 SW	154	307,63 €	52 NW	241	283,05 €	X9166-B10B
------	-------	-----	----------	-------	-----	----------	-------	-----	----------	-------	-----	----------	------------

THRE	75 HW	253	268,17 €	55 MW	197	268,17 €	61 SW	174		71 NW	273	304,27 €	X9144-B11B
	100 HW	302	268,17 €	68 MW	236	268,17 €	77 SW	209		94 NW	327	304,27 €	X9144-B13B

* Kapasite değerleri +4 °C evaporasyon ve +38 °C kondansasyon şartlarındadır.

ALCO DEĞİŞEBİLİR ORİFİSLİ VE FLANŞLI BÜYÜK GÖVDELİ EXPANSION VALF



MOP TABLOSU

MOP		Evaporasyon Sıcaklık Tablosu °C				
CODE	bar	R 22	R 134a	R 404A	R 407C	R 507
15	1,0		-16 °C			
35	2,4	-15°C	0 °C			
40	2,8		11 °C	- 18°C		- 18°C
55	3,8			- 10°C		- 10°C
65	4,5	0°C				
75	5,2			- 2°C		-2°C
80	5,5			0°C		0°C
100	6,9	13°C			14 °C	

Orifice	FLANŞ TİPİ	GÖVDE TİPİ
X22440-B1B	C 501-5 3/8" x 5/8"	XB 1019....1B
X22440-B2B		
X22440-B3B		
X22440-B3,5B		
X22440-B4B		
X22440-B5B	C 501-7 1/2" x 5/8"	
X22440-B6B		
X22440-B7B		
X22440-B8B	A 576 5/8" x 7/8"	
X11873-B4B	10331 7/8" x 7/8"	
X11873-B5B		

X9117-B6B	9153 7/8" x 7/8"	XC726....2B
X9117-B7B		
X9117-B8B		
X9117-B9B		
X9166-B10B		
X9144-B11B	9149 7/8" x 7/8"	
X9144-B13B		



ALCO SABİT ORİFİSLİ EXPANSION VALFLER (DIŞ DENGELİMELİ) TX3



Kompakt boyut
Hermetik tasarım
Korozyona dayanıklı
Büyük diyafram, hassas kontrol
Harici kızgınlık ayarı
Dahili check valf (R407C)
Çift yönlü (heat pump)



Barkodu okutarak ürün
kullanım kılavuzuna
ulaşabilirsiniz.



MODEL	KAPASİTE * KW		GAZ	BAĞLANTI		EVAPORASYON SICAKLIĞI	FİYAT
	TON	KW					
TX3 Z32	0,8 TON	2,8 KW	R410a	1/4" X 3/8"	KAYNAKLI	-45°C..+17°C	60,15 €
TX3 Z33	1,23 TON	4,3 KW					60,15 €
TX3 Z34	1,8 TON	6,3 KW		3/8" X 1/2"			60,15 €
TX3 Z35	2,7 TON	9,4 KW					60,15 €
TX3 Z36	3,7 TON	12,9KW					60,15 €
TX3 Z37	4,53 TON	15,8KW		1/2" X 5/8"			60,15 €
TX3 Z38	5,39 TON	18,8KW					60,15 €

TX3 N61*	0,26 TON	0,9 KW	R407c	1/4" X 3/8"	KAYNAKLI	-45°C..+14,5°C	51,19 €
TX3 N62*	0,71 TON	2,5 KW		1/4" X 3/8"			51,19 €
TX3 N63*	1,1 TON	3,9 KW		1/4" X 3/8"			51,19 €
TX3 N64*	1,6 TON	5,6 KW		3/8" X 1/2"			51,19 €
TX3 N65*	2,4 TON	8,4 KW		3/8" X 1/2"			51,19 €
TX3 N66*	3,32 TON	11,6KW		3/8" X 1/2"			51,19 €
TX3 N67*	4 TON	14,2KW		1/2" X 5/8"			51,19 €
TX3 N68*	4,85 TON	16,9KW		1/2" X 5/8"			51,19 €
TX3 N69*	6,6 TON	23 KW		1/2" X 5/8"			51,19 €

* Kapasite değerleri +4 °C evaporasyon ve +38 °C kondansasyon şartlarındadır.

ALCO SABİT ORİFİSLİ EXPANSION VALFLER (DIŞ DENGELİ)



Kompakt boyut
Hermetik tasarım
Korozyona dayanıklı
Büyük diyafram, hassas kontrol
Harici kızgınlık ayarı
Çift yönlü (heat pump)



Barkodu okutarak ürün kullanım kılavuzuna ulaşabilirsiniz.



MODEL	KAPASİTE * KW		GAZ	BAĞLANTI		EVAPORASYON SICAKLIĞI	FİYAT
	TON	KW					
TX7-N03	8,2	29	R407C R22	1/2" X 5/8"	KAYNAKLI	25°C...+30°C	97,06 €
TX7-N04	10,2	36		5/8" X 7/8"			109,41 €
TX7-N05	12,5	44		5/8" X 7/8"			109,41 €
TX7-N06	20,7	73		7/8" X 1 1/8"			109,41 €
TX7-N07	25,5	90		7/8" X 1 1/8"			109,41 €
TX7-N08	33,6	118		7/8" X 1 1/8"			261,93 €
TX7-N09	47,0	165		7/8" X 1 1/8"			261,93 €

TX7-Z13	9	32	R410A R32	7/8" X 1 1/8"	KAYNAKLI	45°C...+30°C	87,36 €
TX7-Z14	11	40		7/8" X 1 1/8"			98,47 €
TX7-Z15	14	49		7/8" X 1 1/8"			98,47 €
TX7-Z16	23	81		7/8" X 1 1/8"			98,47 €
TX7-Z17	28	99		7/8" X 1 1/8"			98,47 €
TX7-Z18	37	131		7/8" X 1 1/8"			148,37 €
TX7-Z19	52	183		7/8" X 1 1/8"			148,37 €

* Kapasite değerleri +4 °C evaporasyon ve +38 °C kondansasyon şartlarındadır.

ALCO FDB SERİSİ SLİKAJEL DRIER

ADK SERİSİ TAŞ DRIER



MODEL	BAĞLANTI	FİYAT	ÖZELLİKLER
FDB 032	1/4" Rakorlu	10,30 €	<p>Hermetik tasarım Korozyona dayanıklı epoksi boya Giriş ve çıkış boruları bakır Türbülanssız performans Yüksek nem adsorpsiyon kapasitesi Yüksek asit adsorpsiyon kapasitesi Yüksek filtrasyon Çalışma Bıncı 45 bar</p>  <p>Barkodu okutarak ürün kullanım kılavuzuna ulaşabilirsiniz.</p> 
FDB 052	1/4" Rakorlu	13,61 €	
FDB 052S	1/4" Kaynaklı	13,61 €	
FDB 053	3/8" Rakorlu	13,61 €	
FDB 053S	3/8" Kaynaklı	13,61 €	
FDB 083	3/8" Rakorlu	14,67 €	
FDB 083S	3/8" Kaynaklı	14,67 €	
FDB 084	1/2" Rakorlu	14,67 €	
FDB 163	3/8" Rakorlu	18,24 €	
FDB 164	1/2" Rakorlu	18,24 €	
FDB 164S	1/2" Kaynaklı	18,24 €	
FDB 165	5/8" Rakorlu	18,24 €	
FDB 165S	5/8" Kaynaklı	18,24 €	
FDB 303	3/8" Rakorlu	28,22 €	
FDB 304	1/2" Rakorlu	28,22 €	
FDB 305	5/8" Rakorlu	28,22 €	
FDB 415	5/8" Rakorlu	38,85 €	
FDB 417S	7/8" Kaynaklı	38,85 €	

ALCO ADK SERİSİ TAŞ DRIER

MODEL	BAĞLANTI	FİYAT	ÖZELLİKLER
ADK 083	3/8" Rakorlu	20,23 €	<p>Barkodu okutarak ürün kullanım kılavuzuna ulaşabilirsiniz.</p>  
ADK 163	3/8" Rakorlu	22,92 €	
ADK 163S	3/8" Kaynaklı	22,92 €	
ADK 164	1/2" Rakorlu	22,92 €	
ADK 164S	1/2" Kaynaklı	22,92 €	
ADK 165	5/8" Rakorlu	22,92 €	
ADK 165S	5/8" Kaynaklı	22,92 €	
ADK 303	3/8" Rakorlu	36,02 €	
ADK 304	1/2" Rakorlu	36,02 €	
ADK 305	5/8" Rakorlu	36,02 €	
ADK 415	5/8" Rakorlu	49,06 €	
ADK 417S	7/8" Kaynaklı	49,08 €	
ADK 759S	1 1/8" Kaynaklı	89,52 €	

ALCO BFK ÇİFT YÖNLÜ DRIER



Çift yönlü akışı garanti eder
Hermetik tasarım
Korozyona dayanıklı
Giriş ve çıkış boruları bakır
Yüksek nem adsorpsiyon kapasitesi
Yüksek asit adsorpsiyon kapasitesi

Barkodu okutarak
ürün kullanım
kılavuzuna



MODEL	BAĞLANTI	ÖZELLİKLER	FİYAT
BFK 163S	3/8" Kaynaklı	<p>ÇİFT YÖNLÜ (HEAT PUMP)</p>	34,49 €
BFK 164S	1/2" Kaynaklı		36,89 €
BFK 165S	5/8" Kaynaklı		35,40 €
BFK 305S	5/8" Kaynaklı		46,39 €
BFK 307S	7/8" Kaynaklı		48,21 €
BFK 309S	1 1/8" Kaynaklı		52,92 €

KARTUŞ DRIER

MODEL	KULLANIM	ÖZELLİKLER	FİYAT
H48	BASMA		19 €
F48	EMME		48 €

ALCO 2 YOLLU SOLENOİD VALFLER



Kompakt boyut
Minimum basınç düşüşü
Normalde kapalı
IP65 Bobin
Çalışma Basıncı 45 bar
Maksimum çalışma sıcaklığı 120°C
Minimum çalışma aralığı -40°C

Barkodu okutarak
ürün kullanım
kılavuzuna



MODEL	BAĞLANTI	FİYAT	ÖZELLİKLER
110 RB 2T2	1/4"	30,02 €	
200 RB 3T3	3/8"	39,34 €	
200 RB 4T3	3/8"	40,87 €	
200 RB 6T4	1/2"	49,06 €	
200 RB 6T5	5/8"	47,14 €	
240 RA 8T5	5/8"	79,29 €	
240 RA 12T7	7/8"	107,43 €	
240 RA 12T9	1 1/8"	98,83 €	
240 RA 16T9	1 1/8"	155,62 €	
240 RA 16T11	1 3/8"	155,62 €	
240 RA 20T11	1 3/8"	296,19 €	
240 RA 20T13	1 5/8"	296,18 €	
240 RA 20T17	2 1/8"	296,18 €	

BOBİN SOLENOİD VALF FİYATINA DAHİL DEĞİLDİR.

ALCO SOLENOİD BOBİNLER

MODEL	FİYAT	ÖZELLİKLER
ASC	17,45 €	50-60 Hz. 120V, 230V AC - IP65
ASC	16,71 €	50-60 Hz. 24V AC IP65

ALCO KÜRESEL VANALAR



Hermetik dizayn
Pirinç gövde
R410A ve diğer flor gaz uygulamalarına uygun



Barkodu okutarak ürün kullanım kılavuzuna ulaşabilirsiniz.

MODEL	BAĞLANTI	ÖZELLİKLER	FİYAT
BVE 014	1/4"		30,19 €
BVE 038	3/8"		30,19 €
BVE 012	1/2"		34,51 €
BVE 058	5/8"		34,51 €
BVE 034	3/4"		50,69 €
BVE 078	7/8"		50,69 €
BVE 118	1 1/8"		78,19 €
BVE 138	1 3/8"		139,03 €
BVE 158	1 5/8"		158,01 €
BVE 218	2 1/8"		247,08 €
BVE 258	2 5/8"		324,81 €
BVE 318	3 1/8"		336,36 €

ALCO GÖZETLEME CAMLARI



Kesin renk kalibrasyonu
Tam sızdırmazlık
Geniş görüş açısı



Barkodu okutarak ürün kullanım kılavuzuna ulaşabilirsiniz.

MODEL	BAĞLANTI	FİYAT	ÖZELLİKLER
MIA 014	1/4"	18,38 €	
MIA 038	3/8"	19,89 €	
MIA 012	1/2"	20,79 €	
MIA 058	5/8"	20,47 €	
MIA 078	7/8"	28,83 €	
AMI 1TT2	1/4"	32,23 €	
AMI 1TT3	3/8"	37,11 €	
AMI 1TT4	1/2"	42,74 €	
AMI 1TT5	5/8"	46,77 €	
AMI 1TT7	7/8"	39,84 €	
AMI 1TT9	1 1/8"	51,17 €	

KAYNAKLI

ALCO ELEKTRONİK YAĞ SEVİYE REGÜLATÖRLERİ OM3 - TraxOil



Halihazırda kurulu 500.000ad. ile en güvenilir çözüm.
Maksimum çalışma basıncı 35bar, 60bar, 130bar
Alarm çıkış kontağı (230VAC/3A)
Köpürme, ışık gibi hatalara düşmez.
Kolay kurulum.
Led göstergeler.



Barkodu okutarak ürün kullanım kılavuzuna ulaşabilirsiniz.

MODEL	ÖZELLİKLER	FİYAT
OM3-020	OM3 YAĞ SEVİYE REGÜLATÖRÜ GÖVDESİ (20SN)	133,66 €
OM3-120	OM3 YAĞ SEVİYE REGÜLATÖRÜ GÖVDESİ (120SN)	143,40 €
OM0-CUA	FLANŞ 3/4" (D2,D3,D4,D6)	21,89 €
OM3-CBB	FLANŞ 1 1/8" - 18 UNF	27,36 €
OM3-CCA	FLANŞ 3/4" - 14 NPTF (ZF,ZS, ZB15.....ZB48)	36,00 €
OM3-CCB	FLANŞ 1 1/8" - 12 UNF (DK,DL)	27,36 €
OM3-CCC	FLANŞ D8D-D8S	27,36 €
OM3-CCD	FLANŞ 1 3/4" - 12 UNF (ZR90....ZR380, ZB220)	38,31 €
OM3-CCE	FLANŞ 1 1/4" - 12 UNF (ZB50...ZB114, ZR94....ZR190)	50,62 €
OM3-P30	SOLENOİD GÜÇ KABLOSU	12,86 €
OM3-N30	RÖLE BAĞLANTI KABLOSU	6,69 €
ESC 230V AC	BOBİN	17,45 €

Örnek Traxoil Set = OM3-020 + OM3-CUA + OM3-P30 + OM3-N30



ALCO EVAPORATÖR BASINÇ REGÜLATÖRLERİ

MODEL	BAĞLANTI	ÖZELLİKLER	FİYAT
PRE-11A	5/8"	GİRİŞ FİLTRELİDİR DİREKT OLARAK ÇALIŞIR	181 €
PRE-11B	7/8"		181 €
PRE-21D	1 1/8"		304 €

ALCO KARTER BASINÇ REGÜLATÖRLERİ

MODEL	BAĞLANTI	ÖZELLİKLER	FİYAT
PRC-11A	5/8"	GİRİŞ FİLTRELİDİR DİREKT OLARAK ÇALIŞIR	181 €
PRC-11B	7/8"		178 €
PRC-21D	1 1/8"		299 €
PRC-21E	1 3/8"		304 €

ALCO SICAK GAZ BY-PASS REGÜLATÖRLERİ

MODEL	BAĞLANTI	ÖZELLİKLER	FİYAT
CPHE-1	1/2"-5/8"	-0,4 - 5 bara kadar ayarlanabilir, flanşlı (-40/ +120 C)	273 €
CPHE-2	5/8"-7/8"		296 €
CPHE-3	7/8"-7/8"		429 €
CPHE-4	7/8"-7/8"		438 €
CPHE-5	7/8"-7/8"		515 €
CPHE-6	7/8"-7/8"		644 €
ACP-1	1/4"-3/8"		51 €
ACP-3	1/4"-3/8"		57 €
ACP-5	3/8"-3/8"		61 €



ALCO ELEKTRONİK YAĞ

SEVİYE REGÜLATÖRLERİ OM3 - TraxOil



Ayarlanabilir basınç aralığı
Modele bağlı olarak dar ayarlanabilir diferansiyel
Tüm versiyonlar için dayanıklı SPDT kontaklar.
EN 12263'e göre TÜV onayı
DIN 8901 ve EN 378



Barkodu okutarak ürün kullanım kılavuzuna ulaşabilirsiniz.

MODEL	ÖZELLİKLER	FİYAT
PS1 - A3A	Alçak basınç presostatı -0,5/7 bar	37 €
PS1 - A5A	Yüksek basınç presostatı, otomatik reset 6 / 31 bar	35 €
PS1 - R5A	Yüksek basınç presostatı, manuel reset 6 / 31 bar	37 €
PS2 - A7A	Alçak - Yüksek basınç presostatı, otomatik reset ve sinyalli	64 €
PS2 - L7A	Alçak - Yüksek basınç presostatı, manuel reset ve sinyalli	66 €
FD113-ZU	Yağ basınç presostatı	113 €



ALCO ELEKTRONİK BASINÇ PRESOSTATLARI



MODEL	UYGULAMA TİPİ	ON Bar	OFF Bar	ÖZELLİKLER	FİYAT
PS3 W1S	Otomatik Reset	1,2	-0,3		27 €
PS3 W1S	Otomatik Reset	1,8	0,3		27 €
PS3 W1S	Otomatik Reset	3,5	2		27 €
PS3 A6S (Fan Kontrol)	Otomatik Reset	16	11		27 €
PS3 A6S (Fan Kontrol)	Otomatik Reset	19	15		
PS3 A6S (Fan Kontrol)	Otomatik Reset	22,5	26,5		27 €
PS3 W6S	Otomatik Reset	10	14		27 €
PS3 W6S	Otomatik Reset	16	21		27 €
PS3 W6S	Otomatik Reset	20	25		27 €
PS3 W6S	Otomatik Reset	23	29		27 €
PS3 W6S	Otomatik Reset	27,5	33,5		27 €
PS3 W6S	Otomatik Reset	33	40		27 €
PS3 B6S	Manuel Reset		19,2		
PS3 B6S	Manuel Reset		22,7		
PS3 B6S	Manuel Reset		27,3		32 €
PS3 B6S	Manuel Reset		29,5		32 €
PS3 B6S	Manuel Reset		36		

IP65 KORUMALI

MODEL	UYGULAMA TİPİ	ON Bar	OFF Bar	ÖZELLİKLER	FİYAT
PS4-W1	Otomatik Reset	20	26		16 €
PS4-BL	Manuel Reset		42		23 €
PS4-W1	Otomatik Reset	1,8	0,6		23 €
PS4-W1	Otomatik Reset	2,1	0,7		16 €
PS4-A2 (Fan Kontrol)	Otomatik Reset	20	14,6		17 €

ALCO

YAĞ AYIRICI ve EMİŞ AKÜMÜLATÖRLERİ



•Yağ Ayırıcı

- OSH =Hermetik Tip
- OSB = Alttan Flanşlı
- Paslanmaz Çelik İğne ve flatör
- Maksimum 31 bar
- Metal parçacıkları için sabit Miknatıs
- Korozyona dayanıklı epoksi toz boya
- PED97/23 CE / UL Standardına uygun



Barkodu okutarak ürün kullanım kılavuzuna ulaşabilirsiniz.



•Emiş Akümülatörü

- Hermetik Tasarım
- Kolay kaynak için bakır giriş çıkış
- Korozyona dayanıklı epoksi toz boya
- Filtreli yağ dönüş deliği.
- 45oC / +65oC kullanım aralığı
- PED 97/23 CE

ALCO YAĞ AYIRICILAR

MODEL	BAĞLANTI	HACİM	ÖZELLİKLER	FİYAT
OSH 404	1/2"	2 lt	HERMETİK TASARIM PASLANMAZ ÇELİK İĞNE ve FLATÖRLÜ 	132 €
OSH 405	5/8"	2,4 lt		95 €
OSH 407	7/8"	2,8 lt		127 €
OSH 409	1 1/8"	3 lt		159 €
OSH 411	1 3/8"	3,6 lt		172 €
OSH 413	1 5/8"	3,6 lt		219 €
OSH 611	1 3/8"	6,5 lt		255 €
OSH 613	1 5/8"	7,9 lt		258 €
OSH 617	2 1/8"	7,9 lt		322 €
OSB 613	1 5/8"	7,8 lt		FLANŞLI TİP PASLANMAZ ÇELİK İĞNE ve FLATÖRLÜ
OSB 617	2 1/8"	7,8 lt	434 €	

ALCO EMİŞ AKÜMÜLATÖRLERİ

MODEL	BAĞLANTI	HACİM	ÖZELLİKLER	FİYAT
A12-305	5/8"	1,16 lt		43 €
A12-306	3/4"	1,16 lt		46 €
A12-507	7/8"	3,29 lt		82 €
A13-509	1 1/8"	3,80 lt		88 €
A14-611	1 3/8"	5,48 lt		127 €
A20-613	1 5/8"	8,21 lt		154 €